

# EXHIBIT COVER PAGE

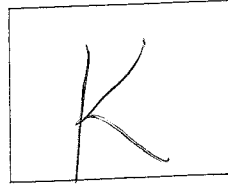

EXHIBIT

DESCRIPTION OF THIS EXHIBIT:

NUMBER OF PAGES TO THIS EXHIBIT: 11 PAGES

JURISDICTION: (CHECK ONLY ONE)

- MUNICIPAL COURT
- SUPERIOR COURT
- APPELLATE COURT
- STATE SUPREME COURT
- UNITED STATES DISTRICT COURT
- STATE CIRCUIT COURT
- UNITED STATES SUPREME COURT
- GRAND JURY



Daryl Kraemer (1991)



Daryl Kraemer (2007)

SECTION 187	CRIME MURDER	CLASSIFICATION	
VICTIM'S NAME - LAST NAME COBB, RITA MABLE		FIRST NAME	MIDDLE NAME (FIRM NAME IF BUSINESS)
ADDRESS	<input type="checkbox"/> RESIDENCE <input type="checkbox"/> BUSINESS	PHONE ( )	

PAGE 2

It was determined that the San Bernardino Sheriff's dept., Homicide team was enroute from San Bernardino and the scene was further protected by Dep. Savage who placed tape across the driveways of both of the residence's as well as using his marked Sheriff's unit to block one of the horse shoe drives.

ADDITIONAL INFORMATION REPORTING PARTY:

Daryl Brent Kraemer, physical address of 6677 Snow Line Rd., Phelan, California 868-4325.

At approx. 1230 hrs., on 9-23-85; I conducted an interview with the above reporting party at the location of the crime scene. I learned from Mr. Kraemer, that he was the son of the victim whom he identified to me as Rita Mabel Cobb. Her DOB 2-23-29 or 30, he was unsure at the time. It was later determined date of birth be 2-23-30 making her a white female 55 years of age. I asked Daryl what the physical address of the residence was, he told me 35435 Hwy 18 Lucerne Valley, Calif., and gave me the phone number of 619/248-7584. During my conversation with Mr. Kraemer I learned he'd last seen his mother approx. 1 to 1 1/2 months ago at her residence in Lucerne. Kraemer told me shortly after his last visit with her, Rita had left country and went to Canada to visit her parents. He's not seen her since she got home approx. 2 weeks ago. Daryl told me his mother's days off are Sunday and Monday from the Spring Valley Lake Country Club, where she works, and at approx. 0930 hrs., this morning, he called her residence trying to get ahold of her to see if they could come out to see her. There was no answer and he felt that she possibly had just stepped outside and would be home shortly, so he and his girlfriend Marta drove to Lucerne Valley to see Rita.

*SAV  
STAN  
SARG  
W. G. K.*

Daryl said he arrived at the house at approx. 1120 hrs., this morning and when he pulled into the driveway he parked his car behind his mother's car in the driveway of the residence. Daryl said the garage door was open which is normal for his mother, he went in through the large garage door and entered the residence through a connecting door using his key. Daryl said he was unsure the door was locked or not, saying he used the key just out of habit. Daryl said he and Marta entered the residence and he noted that the curtains were drawn in the living room and that this was unusual for his mother, because she liked the view and normally kept all of the curtains and drapes in the residence open. He said he could not find her and noticed a strong smell in the residence. As he went into the bedroom of the residence, he saw his mother lying face up nude with her legs spread and what he thought to be stockings on her feet.

Daryl said his first thought was his mother had committed suicide. When I asked him what he meant by that, he said that Rita at times was despondent and very lonely. Daryl told me Marta was directly behind him when he first saw his mother. He immediately left the bedroom and went to the telephone in the residence, said he could not think of any telephone numbers of

REPORTING OFFICER'S TUTTLE T1183	DATE 9-26-85	REVIEWED BY	TYPED BY fj	ROLLED BY	DATE
ACTION: <input type="checkbox"/> NC	COPIES TO: <input type="checkbox"/> Detective	<input type="checkbox"/> SD/PD <input type="checkbox"/> CII	<input type="checkbox"/> Other	REMARKS	

153  
61

SHERIFF'S DEPARTMENT

DR# 1331037-07

County of San Bernardino  
California

CA 03600

REPORT AREA

12+1

Bel  
0213

SECTION PC 187	CRIME MURDER	CLASSIFICATION		
VICTIM'S NAME - LAST NAME CORB, RITA MABEL	FIRST NAME	MIDDLE NAME	(FIRM NAME IF BUSINESS)	
ADDRESS	<input type="checkbox"/> RESIDENCE	<input type="checkbox"/> BUSINESS	PHONE ( )	

PAGE 3

anyone to call so he put the phone down and left the residence in his car to find John Sullivan who is a close friend that lives at the many springs ranch a little farther up Hwy 18. I asked Daryl now he left the residence, if he backed straight down the driveway or used the circular horse shoe driveway and he said he backed down and then proceeded out around the circular drive. Daryl also said Marta was left at the scene in the residence when he left. When he arrived at many springs ranch, he was unable to locate John Sullivan, he again got back in his car and went back to the scene using the same driveway he did previously. Again parking behind the cadillac, he went back inside the residence and entered the bedroom. Daryl said at this point he was extremely emotional and that he'd put his elbows on the foot of the bed resting them in that position. Saying that he wanted to reach out and grab his mother and hold her, but did not.

Daryl stayed a couple of what he describes as seconds and went out of the bedroom and asked Marta if she had called the Sheriff's office. She replied yes, the ambulance had been called and was enroute, Daryl said he took the telephone out the front door of the residence, called the operator and was passed through to the number 911 by the operator. On the telephone, he talked with a male dispatcher from the Sheriff's office who told him not to touch anything or go back inside the residence. Daryl said after he hung up the telephone, Marta and he went outside and stayed outside on the front porch till the ambulance arrived. The fire dept., personnel were told what the Sheriff's office dispatcher had said, then they explained that they needed to go inside to make sure that the person has died and not in need of aid.

So, two men went inside of the residence with Marta behind them, he said that he was extremely upset and yelling at Marta to get back outside and not touch anything, she complied with his request. The fire dept., personnel were immediately behind her. Daryl said he and the fire dept., personnel and Marta stayed on the front porch until Sgt. Quintard and the responding detectives arrived.

*MUST SEE RONALD ROBB'S STATEMENTS*

I asked Daryl if his mother drank to any access and he told me she drank usually by herself, she didn't go out to bars that he knew of to drink. She did have a jeckle and hyde personality when she drank, infact the reason he had not seen her for a month and a half was the last time they'd talked together, the discussion had ended in a disagreement and bad feelings, because she had been drunk at the time. I asked Daryl if he knew anyone his mother had been going out with and he said to his knowledge she hasn't gone out with anyone in the past 4 to 5 months. I asked if his mother was separated, divorced or widowed and he told me she was a widow for approx. 4 years. Daryl added she had a man friend by the name of FRED that she had gone out with several months back but he has not seen her or heard anything about him in quite sometime. I asked if he knew FRED's last name or where I could contact him and he said he did not know his last name, said he worked for Pfizer in Lucerne Valley

INVESTIGATOR G TUTTLE 11183	DATE 9-26-85	VIEWED BY	TYPIST BY tj	ROUTED BY	DATE
TAKER ACTION: <input type="checkbox"/> YES <input type="checkbox"/> NO	COPIES TO: <input type="checkbox"/> Detective	<input type="checkbox"/> SD/PD <input type="checkbox"/> CII	<input type="checkbox"/> Other <input type="checkbox"/> Other	REMARKS	

County of San Bernardino  
California  
CA 03600

DR# 1331037-07

REPORT AREA

SECTION PC 187	CRIME MURDER	CLASSIFICATION	
VICTIM'S NAME - LAST NAME COBB, RITA MABEL		FIRST NAME	MIDDLE NAME (FIRM NAME IF BUSINESS)
OFFICE	<input type="checkbox"/> RESIDENCE	<input type="checkbox"/> BUSINESS	PHONE ( )

PAGE 4

and had been injured on the job, that's all he could tell me about FRED.

I asked if he knew of anyone else that his mother was dating or seeing, and he said no. I asked if there was anybody in the area, or anyone in particular that we could contact in order to learn more information about his mother and the people she was seeing. He gave me the name of John Sullivan, saying that he would be the best contact because John would be down to the house quite often, he helped his mother take care of the place doing repairs when necessary. John was almost a part of the family so close. He added Doris Jackson too, was his mother's best friend, would also be a very good contact however, she is not living in this area now. She lives in Plam Springs somewhere. Daryl said he did not know how to get ahold of Doris off the top of his head, however he was positive her phone number and address would be listed in his mother's telephone book inside the residence. Daryl had nothing further of investigative value and the interview was concluded at that time.

ADDITIONAL INFORMATION STOWE, DON 35370 HWY 18, LUCERNE VALLEY, CALIF., 248-7638:

After concluding the above interview with Daryl Kraemer, I made contact with Mr. Don Stowe who is a neighbor across the highway from the victim, Rita Cobb. I explained the circumstances to Mr. Stowe and that I was part of an investigative team, investigating the death of Rita Cobb and asked if I could speak to him for a few minutes, to which he replied yes. I asked Don how long he had known the victim, Rita Cobb, and he said for several years. He said that they were not exactly the best of friends however, he was acquainted with her and because they were neighbors would keep an eye on her place and her, on occasion when he was outside. Don said in his opinion Rita appeared to be an alcoholic. He said he saw her intoxicated several times and said that when she drank she had what he called a "ball busting" attitude towards men. I asked him what he meant by that, Don said that she would put men down, she had a severe attitude towards men when she'd been drinking and it was very difficult for some people to relate to her, she was very mean when she'd been drinking.

I asked Don when was the last time he had seen Rita alive, he said that she'd been back from Canada just a short time and that she'd gone with Doris Jackson her close friend. I again asked when he'd last seen her, he told me the Monday before, making it a week from the date of interview. I asked Don if he knew of anyone Rita had been going out with, he said that she dated several men, according to "talk" in town, however, he did not know for sure, he told me a man by the name of Frank Strump used to date her but hasn't seen him around in quite some time. I asked where I could find Mr. Strump, he said he was retired and lives in Lucerne Valley someplace but could not give me any further. Don said he has not noticed any strange vehicle in Rita's place in the last several days but did say he noticed there's been no light outside of the residence for approx. a week and this was not her norm, she had been the victim of an attempted STA earlier this year, and since that time, had a light on almost every night or out in

REPORTING OFFICER: TUTTLE T1183	DATE 9-26-85	REVIEWED BY	TYPED BY fj	ROUTED BY	DATE
OTHER ACTION: YES <input type="checkbox"/> NO <input type="checkbox"/>	COPIES TO: <input type="checkbox"/> Detective	<input type="checkbox"/> SD/PD <input type="checkbox"/> CII	<input type="checkbox"/> Other	<input type="checkbox"/> Other	REMARKS

155

RIFF'S DEPARTMENT  
 County of San Bernardino  
 California  
 CA 03600

DR# 1331036-07

REPORT AREA

OFFENSE SECTION PC 187	CRIME MURDER	CLASSIFICATION	
VICTIM'S NAME - LAST NAME COBB, RITA		FIRST NAME	MIDDLE NAME (FIRM NAME IF BUSINESS)
ADDRESS		<input type="checkbox"/> RESIDENCE <input type="checkbox"/> BUSINESS	PHONE ( )

PAGE 10

CONTACT WITH DARYL KRAEMER:

Approx. 1420 hrs, Tuesday 9-24-85, Daryl Kraemer son of the victim, called the Victorville station and left a message where his mother (the victim) best friend could be located.

DORIS JACKSON  
 51480 Avenue Via  
 La Quinta, Calif.,  
 home telephone 619/564-9223

As of this date no contact has been made with Mrs. Jackson

REPORTING OFFICERS APP K 0822	DATE 9-27-85	REVIEWED BY	TYPED BY fj	ROUTED BY	DATE
OTHER ACTION: <input type="checkbox"/> YES <input type="checkbox"/> NO	COPIES TO: <input type="checkbox"/> SD/PD <input type="checkbox"/> Other <input type="checkbox"/> Detective <input type="checkbox"/> CII <input type="checkbox"/> Other <input type="checkbox"/> Dist. Atty. <input type="checkbox"/> Patrol		REMARKS		

RIFF'S DEPARTMENT

County of San Bernardino  
California

CA 03600

DR 1331036-07

REPORT AREA

SECTION PC 187	CRIME MURDER	CLASSIFICATION		
VICTIM'S NAME - LAST NAME COBB,		FIRST NAME RITA	MIDDLE NAME MABLE	(FIRM NAME IF BUSINESS)
ADDRESS		<input type="checkbox"/> RESIDENCE	<input type="checkbox"/> BUSINESS	PHONE ( )

TELEPHONE CONTACT:

Approximately 0852 hours, Friday, 9-27-85, I had telephone contact with DARYL CRAMER. He had telephoned me at my office for his mother's status on her case during which time he gave me information that could be usable in the investigation. He advised me that during his search of his mother's residence on Highway 18 in Lucerne Valley, he mentioned that he could not find a gold chain necklace that she had. He stated it is apparently worth approximately \$1,000.00, maybe more. He described it as a rope type gold chain; he could not give me the length; however, it is approximately one-quarter inch in diameter. He states if there was something wrong with it to be repaired or to be cleaned or something to that nature, she would take it to the Ring Factory located in a shopping center there at Bear Valley Road and Hesperia Road. He also advised me that he recalls approximately three to four months ago that his mother, RITA COBB, had made the statement if anything ever happens to me and the gold chain is missing, it's FRED, meaning FRED BEDARD. He also told me that FRED BEDARD possibly knew HELEN BROOKS. He could not expound upon that statement.

I then asked him if he had possession of the victim's check book. He stated he did and I asked him several questions in regards to deposits and the last checks that were written in her check book. He stated that the last entry was 9-20-85, being a deposit of apparently a paycheck at the bank and then the last check written before that was an insurance payment made on 9-16-85. He stated that there was a check written to PATRICIA's Cafe on 9-15-85, and to Reflections, a place where she apparently got her hair done on 9-13-85. I then requested information about when he receives a phone bill or when his mother receives a phone bill. He stated that they had just received one and that the cut off date was 9-7-85. I then requested of him to notify us as soon as possible or make contact with the telephone company for the new phone bill or toll calls made from the residence in regards to the weekend starting 9-20-85, to 9-23-85.

CONTACT MADE:

On Friday, 9-27-85, Detective BROWN and myself made contact at the Ring Factory located in the Von's Shopping Mall, Hesperia and Bear Valley Road. It was found that no jewelry was at that location that belonged to RITA

REPORTING OFFICERS R. WOODS, Det. W2108	DATE 10-1-85	REVIEWED BY <i>[Signature]</i>	TYPED BY CP P1786	ROUTED BY	DATE
ACTION: YES <input type="checkbox"/> NO <input type="checkbox"/>	COPIES TO: <input type="checkbox"/> Detective <input type="checkbox"/> Dist. Atty.	<input type="checkbox"/> SD/PD <input type="checkbox"/> CII <input type="checkbox"/> Patrol	<input checked="" type="checkbox"/> Homicide <input type="checkbox"/> Other	REMARKS	

SHERIFF'S DEPARTMENT  
 County of San Bernardino  
 California  
 CA 03600

DR#1331036-07  
 REPORT AREA

121

196

SECTION 187	CRIME MURDER	CLASSIFICATION STRANGULATION
NAME - LAST NAME COBB, RITA	FIRST NAME	MIDDLE NAME (FIRM NAME IF BUSINESS)
ADDRESS	<input type="checkbox"/> RESIDENCE <input type="checkbox"/> BUSINESS	PHONE ( )

S U P P L E M E N T A L

CONTACT WITH DARRYL KRAEMER: (son of victim)

At approximately 1500 hours, Monday, 9-15-86, I made telephone contact with Mr. DARRYL KRAEMER, son of the victim RITA COBB. I asked Mr. KRAEMER if he would be available to come to the Victorville Station where I could process a set of latent fingerprints from him for further investigative leads and for elimination purposes.

At approximately 1000 hours, Tuesday, 9-16-86, Mr. KRAEMER came to the Victorville Sheriff's Station. At that time I took two latent print cards and one palm card from Mr. KRAEMER'S hands. I then asked Mr. KRAEMER if he had any objections to giving me a blood sample for further evidentiary value. He stated he did not and we then proceeded to St. Mary's Urgent Care Center where Sex Kit #006619 was used to obtain a blood sample, drawn by LVN SHERRY FONHAM at approximately 1135 hours, this date.

IT SHOULD ALSO BE NOTED that during the period we were at St. Mary's Urgent Care Center and just prior to the blood being drawn by LVN FONHAM, I took a saliva sample using two cotton swabs found in the Sex Kit #006619 to attain a saliva sample from Mr. KRAEMER'S mouth.

It was during the collection of this evidence that we, again, asked Mr. KRAEMER what he had heard about his mother's death. He stated the following.

INTERVIEW WITH DARRYL KRAEMER:

GIBBS HAD RELATIONS WITH COBB AND KILLED HIS WIFE EXACTLY AS COBB AND BROWN WAS PRESUMABLY

Mr. KRAEMER said that approximately June of 1986 he had heard from PHYLLIS, a bartender at the Zodiac Lounge, that a white, male known only as PETERSON, had come in and told her that another individual, known only as GIBBS, believed to be MERYL GIBBS, had told him (PETERSON) that he had killed a woman approximately two to three months prior to GIBBS' death. PETERSON then told Phyllis that GIBBS had committed suicide after he had killed his wife and possibly GIBBS was responsible for the death of RITA COBB. He also stated that perhaps the other items ought to be checked out and we asked what he was speaking of and he stated the residence directly across the street from his mother's home, on Highway 18 in Lucerne Valley, is occupied by a family identified as the STONES. The owner, DAN STONE, had a son described as a white, male adult, 32 years of age, 200 pounds living at that residence at the time of his mother's death and within a couple of days after the death Mr. STONES son left the area. Mr. KRAEMER thought this was unusual and asked that this be investigated also.

REPORTING OFFICERS P. DEPUTY, K-0822	DATE	REVIEWED BY	TYPED BY JEANIE/10-16-86	ROUTED BY	DATE
ACTION: YES <input type="checkbox"/> NO <input type="checkbox"/>	COPIES TO: <input type="checkbox"/> Detective <input type="checkbox"/> Dist. Atty.	<input type="checkbox"/> SD/PD <input type="checkbox"/> CII <input type="checkbox"/> Patrol	<input type="checkbox"/> Other <input checked="" type="checkbox"/> Other	REMARKS 3 151	

KRAEMER SUSPECT AFTER 1 YEAR



SHERIFF'S DEPARTMENT

County of San Bernardino  
California

CA 03600

DR#1331036-07

REPORT AREA

PAGE TWO	SECTION	CRIME	CLASSIFICATION
PG 187			
VICTIM'S NAME - LAST NAME		FIRST NAME	MIDDLE NAME (FIRM NAME IF BUSINESS)
COBB, RITA			
ADDRESS		<input type="checkbox"/> RESIDENCE <input type="checkbox"/> BUSINESS	PHONE ( )

INTERVIEW WITH DARRYL KRAEMER: (Continued)

We then asked Mr. KRAEMER if he knew of any relations or ties his mother had to the Palm Desert, Coachella, Indio, etc. area and he responded by saying that a DORIS JACKSON, a close friend of his mother, had at one time lived in the Palm Springs area, however she is currently living in Missouri, and she has two sons whose names are unknown. He also stated that DORIS has a guy living with her at the time and his name was KEN, unknown last.

We then questioned DARRYL KRAEMER as to his mother's background and marital history. He stated that his mother had been married to Mr. COBB approximately 10 years. This was the third marriage for her. He stated that his real father was his mother's first marriage, and that had lasted approximately 12 years. His real father is currently living in Texas. He stated that her second husband, identified as a PAUL SIMON, who has a son of his own, identified as PAUL SIMON, JR.; they are both currently living in the Lancaster area. She was married to him for approximately 3 years. This marriage ended in divorce and subsequently she married Mr. COBB, to whom she had been married for 10 years until his death, approximately 1979 or 1980.

Mr. KRAEMER stated, initially, that he suspected PAUL SIMON, JR. of perpetrating this type of crime as he is currently living with MARTA SIMON, PAUL SIMON JR's, ex wife and at one time the Sr. SIMON had made mention that he (DARRYL KRAEMER) had stolen his son's wife, and he would get back at them somehow. He stated that PAUL SIMON Sr., his former step-father, is a retired Army sergeant and the last time he had seen him was in 1983. He could add nothing further of investigative value to the marital status and family history of his mother.

ARRIVAL OF SAN BERNARDINO COUNTY SHERIFF'S CRIME LAB:

At approximately 0930 hours, Wednesday, 9-17-86, Detective BESKY arrived at the San Bernardino County Sheriff's Crime Lab where we met with Criminalist PHILLIP KELLET. We gave San Bernardino County Sex Kit #006619 and Mr. KELLET analyzed the same in our presence. We were advised that DARRYL KRAEMER'S blood type was type A, thereby eliminating him as a possible suspect in the homicide of his mother RITA COBB. Refer to Crime Lab supplemental report. *DARRYL WAS A SUSPECT*

LATENT PRINTS:

The latent prints received from DARRYL BRENT KRAEMER will be held in the case file pending the disposition of the latent prints being identified through the California

REPORTING OFFICERS [Name], DEPUTY, K-0822	DATE	REVIEWED BY	TYPED BY JEANIE/10-16-86	ROUTED BY	DATE
ACTION: <input type="checkbox"/> YES <input type="checkbox"/> NO	COPIES TO: <input type="checkbox"/> Detective <input type="checkbox"/> Dist. Atty.	<input type="checkbox"/> SD/PD <input type="checkbox"/> CII <input type="checkbox"/> Patrol	<input type="checkbox"/> Other <input type="checkbox"/> Other	REMARKS  <i>158</i>	

SHERIFF'S DEPARTMENT  
 COUNTY OF SAN BERNARDINO  
 CALIFORNIA  
 CA 03600

Page 1

133103607

REPORT AREA

H100-85

SECTION PC 187	CRIME Murder	CLASSIFICATION	
VICTIM'S NAME - LAST NAME	FIRST NAME	MIDDLE NAME	(FIRM NAME IF BUSINESS)
ADDRESS	RESIDENCE		PHONE

WITNESS INTERVIEW: DARYL AND MARTA KRAEMER:

On Sunday, February 22, 2009, at approximately 1000 hours, Detective Rob Alexander and I interviewed Marta and Daryl Kraemer at the Victorville City Sheriff's Station. Present for the interview was Marta, Daryl, Alexander, and I. Daryl is the son of the decedent Rita Cobb. Marta is Daryl's wife. At the time of the murder Daryl and Marta were boyfriend/girlfriend and both found Rita deceased in the house in 1985. Marta's maiden name is Simon. We asked both of them numerous questions and the following is a summary of their audio recorded statement.

*summary of their audio recorded statement*  
 WHERE IS VERBATIM OF RECORDING

Marta and Daryl have been married for the last 18 years.

Daryl said his mother Rita Cobb drank a lot of hard alcohol back in the 1980's leading up to her murder. When Rita drank she could become very mean and nasty towards others.

On or about July, 1985 Rita and her friend Doris Jackson took a trip to Canada. Doris was one of Rita's best friends. They stayed in Canada for 2-3 weeks and then returned home.

Rita frequented the bars in Lucerne Valley. On or about September, 1985 Rita left Daryl a message on his telephone answering machine. Rita was worried about something and said she needed to talk to him. Daryl believes the message was close in time to when she was murdered.

*WHAT MAKES HIM SAY THIS, WHAT DOES HE KNOW*

After receiving the telephone message he returned his mothers call several times over the weekend, but he never got a hold of her. After receiving no reply over the weekend Daryl telephoned Rita's work on Monday morning. Daryl was informed by Rita's boss that Rita had not shown up to work. It was then that Marta and he drove to Rita's house and found her dead.

*FILED*  
 Brad Bedard was one of Rita's boyfriends near the time of her murder, but he has since passed away.

*BERDARD WAS ALLEGEDLY TO STEAL NECKLACE AND HE WORE A GOLD WATCH ON LEFT WRIST*

REPORTING OFFICER Detective G. Myler #M4285	DATE 02/23/09	REVIEWED BY FM	TYPED BY Mary	ROUTED BY	DATE
OTHER ACTION: <input type="checkbox"/> NO	COPIES TO: <input type="checkbox"/> Detective <input type="checkbox"/> Dist. Atty.	<input type="checkbox"/> Other <input type="checkbox"/> CII <input type="checkbox"/> Patrol	<input type="checkbox"/> SD/PP <input type="checkbox"/> Other	REMARKS  <i>159</i>	

SHERIFF'S DEPARTMENT  
 COUNTY OF SAN BERNARDINO  
 CALIFORNIA  
 CA 03600

Page 9

133103607

REPORT AREA

H100-85

SECTION PC 187		CRIME Murder		CLASSIFICATION	
VICTIM'S NAME - LAST NAME		FIRST NAME	MIDDLE NAME	(FIRM NAME IF BUSINESS)	
ADDRESS			RESIDENCE	PHONE	

Interview Continued: Daryl and Marta Kraemer

We asked Daryl and Marta who we should talk to if we want to find out more about the Yablonsky family. Daryl said we should talk to Pam Hardwick. Pam and George never had any kids together but Pam would be a great source of information because she was a big gossiper and routinely gathered information because that is the type of person she was back then. Daryl said he thinks Pam will be a "gold mine" of information.

*EVERYONE SAYS DIFFERENT WHY DOES HE CHANGE HER ROUTINE NOW*  
 Daryl said when he lived with his mother she was not a real late night person on Friday and Saturday evenings. *His mother did go out to the bars but usually would return home by midnight.* She was not the type of person who would close down the bar. On Sunday nights through Thursday nights she would go to bed maybe between 10:00 and 11:00 PM in order to get enough sleep for work.

Daryl said Pam Hardwick has three children. They are Harley Langford, Minnie Langford and Tony Romero. Daryl suggested that we don't talk to Pam unless we are willing to take the chance that information may slip out to others prior to a suspect interview. Daryl suggested that it would be better to talk to Pam after an arrest or suspect interview.

Daryl and Marta did not have any further information to provide at this time and their interview was concluded at approximately 1240 hours.

*THIS MAN IS PARTNER WITH DET. ALEXANDER WHO ALTERED THIS INTERVIEW. WHAT IS THE VERBATIM OF*

REPORTING OFFICER Detective G. Myler #M4285	DATE 02/23/09	REVIEWED BY EM	TYPED BY Mary	ROUTED BY	DATE
OTHER ACTION: <input type="checkbox"/> NO	COPIES TO: <input type="checkbox"/> Detective <input type="checkbox"/> Dist. Atty.	<input type="checkbox"/> Other <input type="checkbox"/> CII <input type="checkbox"/> Patrol	<input type="checkbox"/> SD/PA <input type="checkbox"/> Other	REMARKS	

REGIONAL FORENSIC SCIENCE LABORATORY  
 County of San Bernardino — Sheriff's Department

120  
195

OVERVIEW

ABO/Lewis typed  
 G-1 AB Le<sup>s</sup>-Le<sup>t</sup>  
 - elimination - DCA 9-25-92

RECORD OF VERBAL REPORTS BY LABORATORY:

1. Date \_\_\_\_\_ Time \_\_\_\_\_  
 To \_\_\_\_\_  
 How \_\_\_\_\_  
 Initialed \_\_\_\_\_

2. Date \_\_\_\_\_ Time \_\_\_\_\_  
 To \_\_\_\_\_  
 How \_\_\_\_\_  
 Initialed \_\_\_\_\_

3. Date \_\_\_\_\_ Time \_\_\_\_\_  
 To \_\_\_\_\_  
 How \_\_\_\_\_  
 Initialed \_\_\_\_\_

REGIONAL FORENSIC SCIENCE LABORATORY

County of San Bernardino — Sheriff's Department  
 200 S. Lena Rd.  
 San Bernardino, CA 92415  
 Phone: (714) 387-2200

EVIDENCE

DATE	TIME	HRS	REL. NO.
11/7/86	10:49		1331036-07
RECEIVED BY: <i>Rita Cobb</i>			
THE FOLLOWING WAS RECEIVED: <i>in lab</i>			
FROM: <i>SBSD - Det. R. Knapp</i>			
THIS DATE			
RECEIVED BY: <i>Kob/ME</i>			
FROM: _____			
CASE NO: <i>44659</i>			
TITLE: <i>Homicide 01</i>			

*(1) Physical evidence (blood, saliva standards) from Danny KRUMER (son of victim) S.O. Lit 06619*

*156*

# EXHIBIT COVER PAGE

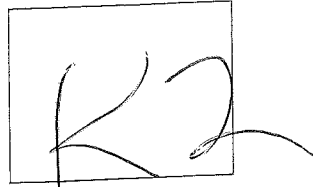

EXHIBIT

DESCRIPTION OF THIS EXHIBIT:

NUMBER OF PAGES TO THIS EXHIBIT: 4 PAGES

JURISDICTION: (CHECK ONLY ONE)

- MUNICIPAL COURT
- SUPERIOR COURT
- APPELLATE COURT
- STATE SUPREME COURT
- UNITED STATES DISTRICT COURT
- STATE CIRCUIT COURT
- UNITED STATES SUPREME COURT
- GRAND JURY

12+

12/13

County of San Bernardino  
California  
CA 03600

DR 1001000-01  
REPORT AREA

SECTION PC 187	CRIME MURDER	CLASSIFICATION STRANGULATION
VICTIM'S NAME - LAST NAME COBB	FIRST NAME RITA	MIDDLE NAME (FIRM NAME IF BUSINESS) MABLE
ADDRESS 35345 Hwy 18, Lucerne Valley, CA	<input type="checkbox"/> RESIDENCE <input type="checkbox"/> BUSINESS	PHONE ( ) 248-7584

Page 4

CONTACT AT ZODIAC BAR:

At approximately 2040 hours, Monday, 9-23-85, we made contact at the Zodiac Bar with the bartender DAWN DISMORE. I asked DAWN and showed her a picture of RITA COBB, and asked her if she knew her. DAWN stated that she did and was aware of RITA, she had been in her about a month and a half ago and was very intoxicated and she stated that's the last time that she has seen her, only one time. I asked her specifically if she had been in there Friday or Saturday night and she stated that she had been the night bartender on those particular nights and had not seen her at all.

While we were leaving the Zodiac Bar we were approached by a VAL LEMOS, Mexican male, 50 years, who lives in Big bear, home phone number of 585-3931. This was approximately 2045 hours, 9-23-85. Mr. LEMOS told us of an incident occurring earlier that evening where a subject wearing a L.A.P.D. black hat, blonde hair, skinny, blonde moustach and beard, stated that he was in the bar and he had never seen him in there before and was talking to a female subject that was a local that lived in the area. He stated that she was sitting there and he kept making an approach on her, finally started calling her names such as dirty bitch and telling her to get fucked. He stated that this occurred about 1800 hours, Monday. He stated the girl now is gone but is the girlfriend of a subject by the name of GENE. The information was taken from Mr. LEMOS, the contact was concluded.

Second contact at the Zodiac Bar that night was with RONALD KOBS, he's the local propane gas man, works for Sun Propane there in Lucerne Valley. Mr. KOBS stated he had heard what had happened to RITA and he stated that back on August 15th or 18th, somewhere in that particular area, 1985, that he was called out to the COBB residence and when he went out to survey the property for a possible propane tank construction that there was a dark headed subject with a beard and moustach that he found out later was RITA's son, was there and was very violent acting towards his mother, calling her dirty names and grabbing her by the front of the shirt calling her dirty names to her face. Mr. KOBS stated that RITA COBB was not acting as if she were all there either. He stated that he tried to explain the insertion of the propane tank to her several times and she was just not understanding. Contact with Mr. KOBS was concluded.

REPORTING OFFICERS WOODS, Det. W2108	DATE 9-26-85	REVIEWED BY <i>[Signature]</i>	TYPED BY jo 00397	ROUTED BY	DATE
ACTION: YES <input type="checkbox"/> NO <input type="checkbox"/>	COPIES TO: <input type="checkbox"/> Detective <input type="checkbox"/> Dist. Atty.	<input type="checkbox"/> SD/PD <input type="checkbox"/> CII <input type="checkbox"/> Patrol	<input type="checkbox"/> Other <input type="checkbox"/> Other	REMARKS	

TOP LEFT

← BARSTON

OLD NORMAL

SPRING RD

JOSHUA ↑

BARSTON ROAD

4WAY STOP

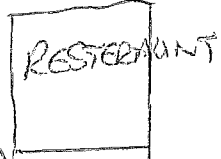
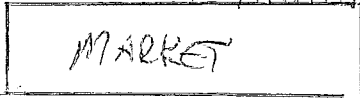
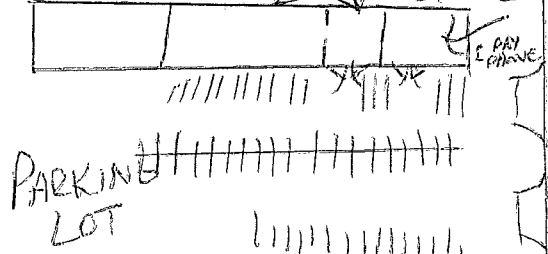
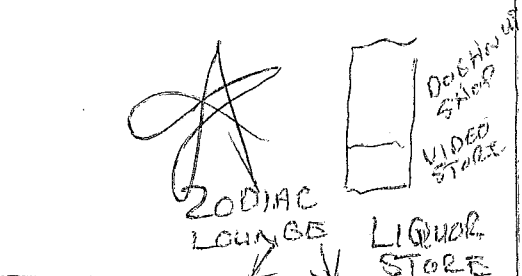

STANDARD  
TWO LANE  
HIGHWAY →



↑  
TO BIG BEAR

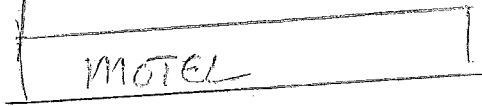
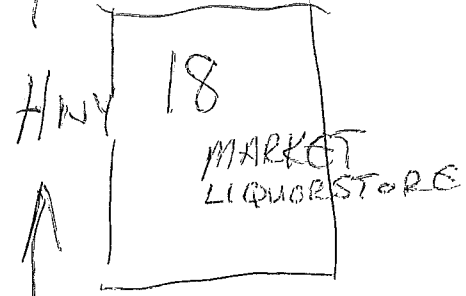

TOP VIEW  
OF  
PROPERTY  
LOCATION

AS WAS IN 1985

K-2 EXHIBIT

TOP LEFT

ZODIAC LOUNGE  
FRONT VIEW FROM MARKET  
NOBODY IN BAR AREA  
SEE ANYONE IN LOUNGE CAN  
PARKING LOT

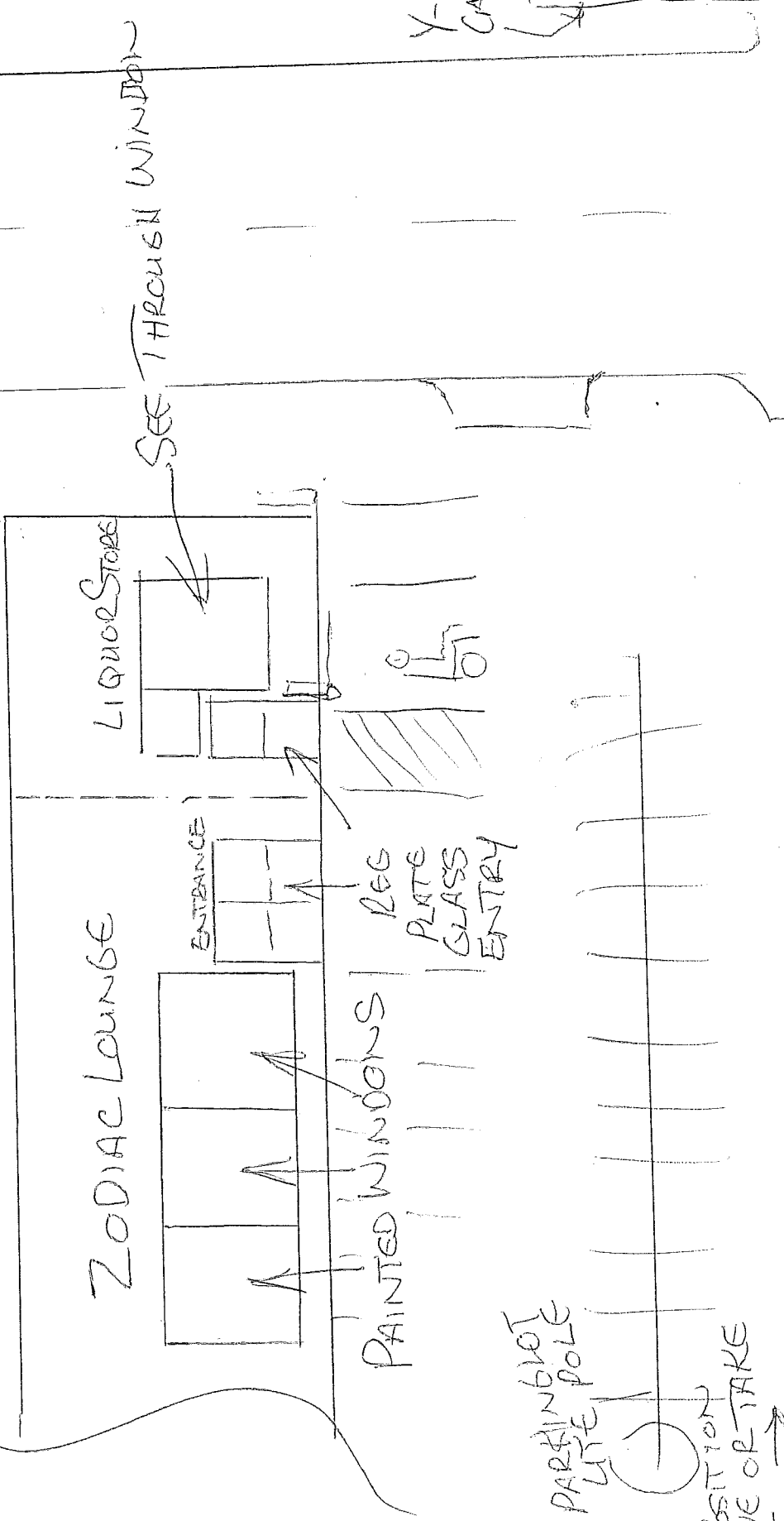

K-2 EXHIBIT

AS WAS IN 1985



HOW DID DAWN WORKING THE BAR SEE THE LOUNGE SEATING AREA OR THE OBSCURED PARKING LOT FROM HER WORK STATION WHEN THE LITES ARE DIMMED FOR PARTYING

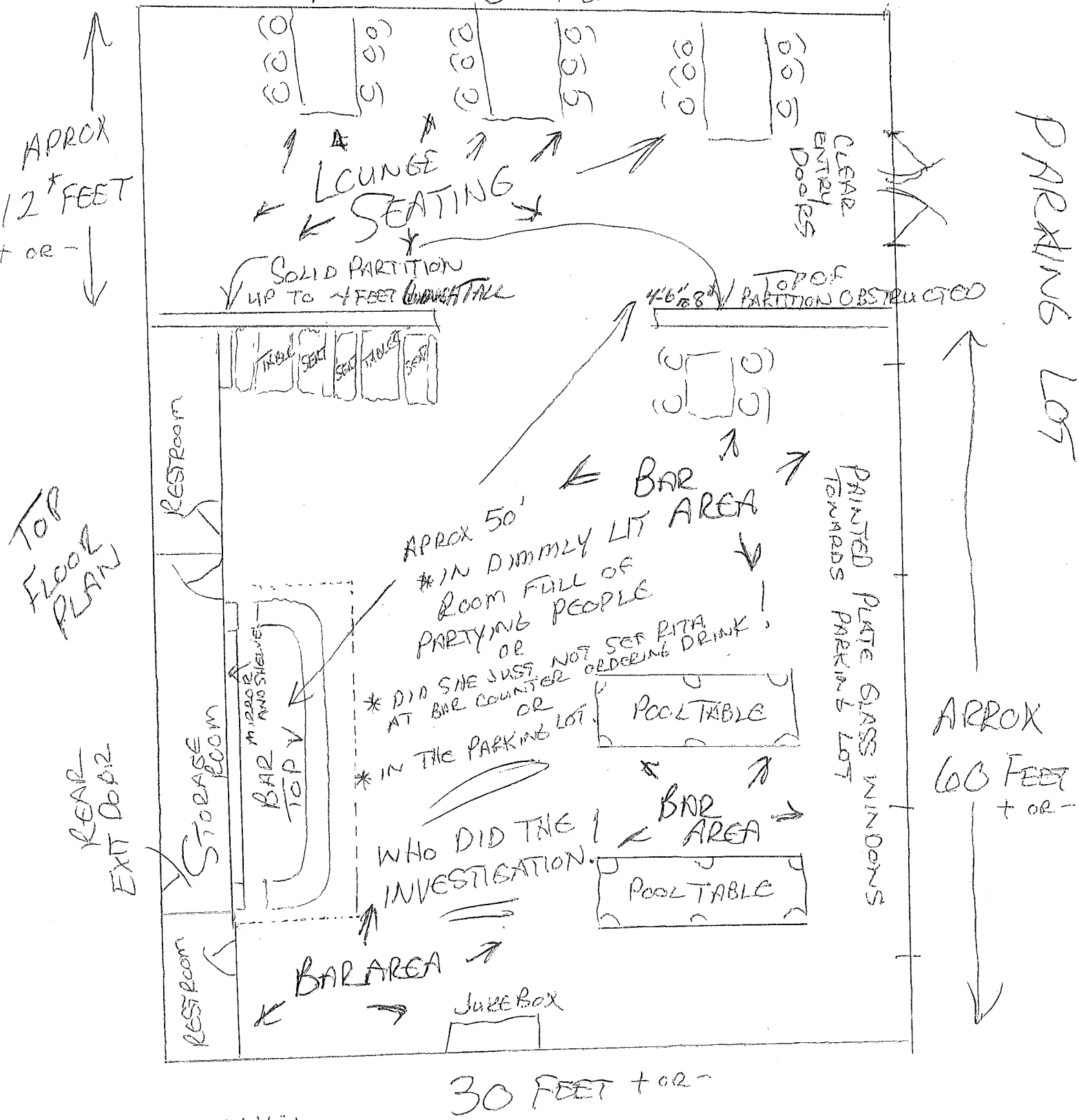

DAWN DISMORES WORK STATION BEHIND THE BAR AT 1130 AM ON FRIDAY NITE AS WAS IN 1985

K-2 EXHIBIT

# EXHIBIT COVER PAGE

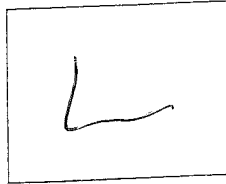

EXHIBIT

DESCRIPTION OF THIS EXHIBIT:

NUMBER OF PAGES TO THIS EXHIBIT: 2 PAGES

JURISDICTION: (CHECK ONLY ONE)

MUNICIPAL COURT

SUPERIOR COURT

APPELLATE COURT

STATE SUPREME COURT

UNITED STATES DISTRICT COURT

STATE CIRCUIT COURT

UNITED STATES SUPREME COURT

GRAND JURY

SHERIFF'S DEPARTMENT  
 COUNTY OF SAN BERNARDINO  
 CALIFORNIA  
 CA 03600

9/10  
 Page 1

H #100-85  
 REPORT AREA

272  
 60  
 185

SECTION 187	CRIME MURDER	CLASSIFICATION	
VICTIM'S NAME - LAST NAME COBB,	FIRST NAME RITA	MIDDLE NAME MARBEL	(FIRM NAME IF BUSINESS)
RESIDENCE		PHONE	

CONTACT FROM FBI/VICAP: (703) 632-4163

On 11/27/02, I received a phone call from FBI VICAP Analyst Ken Witlow, phone number (703) 632-4163, regarding the following SBSD homicide investigations:

DR # 1331490-07/H #68-85

Victim: Brooks, Helen Margaret  
 WFA-63, DOB: 07/11/22  
 Found: Friday, 07/05/86  
 Location: 19001 Highway 18, Apt. #2, Apple Valley, CA  
 Suspect: Unknown

DR # 1331036-07/H #100-85

Victim: Cobb, Rita Marbel  
 WFA-55, DOB: 02/23/30  
 Found: Monday, 09/23/85  
 Location: 35435 Highway 18, Lucerne Valley, CA  
 Suspect: Unknown

*DUING POS INVESTIGATION  
 WE TOLD DETECTIVES HE WAS  
 IN CARCELATED DURING THIS  
 CRIME, BUT WAS ACTUALLY  
 IN JAIL 5 MONTHS BEFORE  
 MAKING HIM STILL A  
 PRIME SUSPECT.*

Witlow said through their review of the two SBSD cases, they found (4) similar murder cases from (4) jurisdictions that occurred from 1986-1989. Witlow said he contacted the other agencies regarding the similarities in each case. The following cases were given:

LOS ALAMITOS PD CASE #860764

Victim: Deeble, Majorie Elaine  
 Found: May 12, 1986  
 Suspect: Edwards, Robert Mark WMA-41, DOB: 06/14/61, (Arrested/In-Custody since 1997)  
 Contact: Sgt. Travis/Los Alamitos Homicide, (562) 431-2255

\*\*\*Edwards was later convicted for this murder in 1998 and sentenced to death\*\*\*

REPORTING OFFICER T. CARLOS A. ESPINOZA E-0802	DATE 12/02/02	REVIEWED BY	TYPED BY cae	ROUTED BY	DATE	
ACTION: <input type="checkbox"/> NO		COPIES TO: <input type="checkbox"/> Detective <input type="checkbox"/> SD/DP <input type="checkbox"/> CII <input type="checkbox"/> Other <input type="checkbox"/> Dis. Alt. <input type="checkbox"/> Patrol		REMARKS		

21/3  
 119 327

SHERIFF'S DEPARTMENT  
 COUNTY OF SAN BERNARDINO  
 CALIFORNIA  
 CA 03600

9/10

Page 2

1337030-11  
 H #100-85  
 REPORT AREA

273  
 136

SECTION	CRIME	CLASSIFICATION	
U-187	MURDER	(FIRM NAME IF BUSINESS)	
VICTIM'S NAME - LAST NAME	FIRST NAME	MIDDLE NAME	PHONE
DOB	RITA	MARBEL	
ADDRESS	RESIDENCE		

CONTACT FROM FBI/MICAP: (continued)  
LOS ANGELES COUNTY SHERIFF CASE #086074941617

Victim: Belcher, Rhonda  
 Found: June 26, 1986  
 Suspect: Unknown  
 Contact: Sgt. Joe Hartshorne/LASO Homicide, (323) 890-5641

COSTA MESA PD CASE # 88-59459

Victim: Gibbons, Malinda  
 Found: July 18, 1988  
 Suspect: Unknown  
 Contact: Sgt. Archer/Costa Mesa PD Homicide, (714) 754-5395

LOS ANGELES PD CASE # 89-1123392

Victim: Kreismanis, Brigita  
 Found: August 5, 1989  
 Suspect: Unknown  
 Contact: Det. Berdin/LAPD Homicide, (213) 847-4261

*MICAPING PEE  
 A SUSPECT TO  
 COBBS AND BROOKS  
 STILL*

*9/23/85*

I ran a records check regarding the Los Alamitos suspect (Robert Mark Edwards/CII #A06751443). Edward's records showed he was arrested/in-custody at CDC on 12/10/85, until he was paroled on 12/12/85. On 11/27/02, I contacted the CDC Statewide Parole Locator Service/OBIS (916-358-1847) and spoke to Record's Clerk Scott Johnson. Upon review of their records, Johnson confirmed Edwards was incarcerated from 12/85-12/86.

Based on this information, Edwards could not be a suspect in our murder investigation because he was incarcerated at the time of the murders.

*IN CUSTODY BETWEEN  
 SEE PAROLED  
 ON 12/86 NOT STAYED  
 12/85 AS M6*

REPORTING OFFICER CARLOS A. ESPINOZA E-0802	DATE 12/02/02	REVIEWED BY	TYPED BY CAE	ROUTED BY	DATE
ACTION: <input type="checkbox"/> NO	COPIES TO: <input type="checkbox"/> Del. Atty. <input type="checkbox"/> Dist. Atty.	<input type="checkbox"/> Other <input type="checkbox"/> SD/PP <input type="checkbox"/> Other	REMARKS		

*2-23/1 50*

**DIVISION OF ADULT INSTITUTIONS****NORTH KERN STATE PRISON**

2737 W. Cecil Avenue  
P. O. Box 567  
Delano, California 93216



August 9, 2012

John Yablonsky, CDCR #AL0373  
Facility D, Building 5-214L  
North Kern State Prison

Inmate Yablonsky:

This response is in regard to your correspondence dated July 22, 2012. You request authorization to correspond with Inmate Robert Edwards, California Department of Corrections and Rehabilitation (CDCR) number P11700, who is currently housed at San Quentin State Prison.

If Inmate Edwards is in agreement with your request, a CDCR Form 1074, Request for Correspondence Approval, is required. A CDCR Form 1074 has been forwarded to Inmate Edwards for completion. A copy of your letter will be placed in your central file.

I hope this information is of assistance. If you have any other concerns regarding this or any other matter, please contact your assigned counselor, O. Quiroz, Correctional Counselor I, via a CDCR Form 22, Inmate/Parolee Request for Interview, Item or Service.

Sincerely,

  
P.L. VAZQUEZ  
Warden (A)

Enclosure

Cc: C-File, Inmate Yablonsky, AL0373

(C) 4 COPIES

STATE OF CALIFORNIA  
REQUEST FOR CORRESPONDENCE APPROVAL  
CDCR 1074 (REV. 08/08)

DEPARTMENT OF CORRECTIONS AND REHABILITATION

FR: P. L. VAZQUEZ

TITLE: WARDEN (A)

INSTITUTION/PAROLE REGION: NORTH KERN STATE PRISON

ADDRESS: 2737 W. CECIL AVENUE  
DELANO, CA 93216

TO: K. CHAPPELL

TITLE: WARDEN (A)

INSTITUTION/PAROLE REGION: SAN QUENTIN STATE PRISON

ADDRESS: SAN QUENTIN, CA 94964

1. INMATE/PAROLEE REQUESTING TO CORRESPOND:  
YA BLONSKY, JOHN H.

CDC NUMBER: ALO373

CURRENT STATUS:  INMATE  PAROLEE

2. INMATE/PAROLEE UNDER YOUR JURISDICTION:  
EDWARDS, ROBERT

CDC NUMBER: P11700

CURRENT STATUS:  INMATE  PAROLEE

KNOWN GANG AFFILIATION(S):  
NONE

KNOWN GANG AFFILIATION(S):  
NONE KNOWN

MISCELLANEOUS INFORMATION/COMMENTS:  
NONE

MISCELLANEOUS INFORMATION/COMMENTS:

COUNSELOR/AGENT'S RECOMMENDATION:  
 APPROVED  DENIED for the following  
reason:

COUNSELOR/AGENT'S RECOMMENDATION:  
 APPROVED  DENIED for the following  
reason:

COUNSELOR/AGENT'S SIGNATURE: B Sprister

DATE: 8.9.12

COUNSELOR/AGENT'S SIGNATURE:

DATE:

COUNSELOR/AGENT'S NAME (TYPED OR PRINTED):  
B Sprister

COUNSELOR/AGENT'S NAME (TYPED OR PRINTED):

SUPERVISING AUTHORITY'S DECISION:  
 APPROVED  DENIED for the following  
reason:

SUPERVISING AUTHORITY'S DECISION:  
 APPROVED  DENIED for the following  
reason:

SIGNATURE: D. Edelstein

DATE: 8.9.12

SIGNATURE:

DATE:

TITLE: CG111 (A)

TITLE:

INSTRUCTIONS:  
If request is denied, note reason and notify inmate/parolee #1  
If request is approved by requesting facility, retain pending copy and forward request to inmate/parolee #2's supervising authority.

INSTRUCTIONS:  
Receiving facility to retain last two copies (1 for inmate/parolee, 1 for inmate/parolee's file and return to requesting facility.)

DISTRIBUTION (After processing):  
Original - Inmates/Parolee #1's File  
Copy - Inmates/Parolee #1  
Copy - Inmates/Parolee #2's File  
Copy - Inmates/Parolee #2  
Copy - Retained by requesting facility until process completed.

19 December 2010

John,

Well, I must admit that with the holidays being upon us, it can at times be rather pressing for the fella's and myself. Your letter certainly plenty of laughter and joy to us all. You're the laughing stock of the row. Thanks for the laughs! Come on now...don't plex up now...Go ahead and finish the rest of this. As you can see it's not long,

First of all...Clearly you didn't do your homework very well. If you had then you'd of seen the fact that while your running and I didn't even <sup>prole</sup> ~~leave~~ until 12/12/55. I was NEVER questioned for anything like that at all by the fed's. Your in denial at. Coathenger John with the cold DDA hit. OUCH! That had to hurt, eh? Damn that cna, huh? Hee-hee-hee! I had given cna back then when I was asked, plus, they came up here and took everybody's. Hell, they'd of got ya then. There was ZERO cna in my case, all there wasm but it wasn't mine. Hmm...maybe it's yours! By the way..

I am DADDY! Just like EVERYONE of d.a., get with the program. Everybody knows that, Jackass. Now, let's get y to your whole, "I'm a christain"b.s. If so, then you should follow a Dr. King's advice, "The truth shall set you free!" Fess up, Buttercup. It's good for the soul. Maybe they'll spare your ass if you save them the hassle and "do the right thing" as you say. Boy you got nerve! Why would I or anyone for that matter want to assist you, some guy who's been out there wrapping coathengers around lil ole ladies necks?!? I support the d.p. and you fit the mold of cna's caesar-ving the d.p.. Oh...I LOVED the hardcore madboy stare on your magshot. Ah...Ya scared me just with that on paper. ~~WATER!~~ ~~WATER!~~ Too too mean

What your the only one who's got a family? What about that last fella's family?! Oh, I can't wait to see what her son has to say to you in penalty phase. The Only sympathy your going to get is what you get in your penalty phase so suck it all up then. Your not going to find anyone to believe your sob story. About all you'll find here are fingers being pointed at you with snickers and laughs when those who will know of you sees you and laughs their asses off at your act of sheer desperation. What else can it be when your up the creek without a paddle. Your probably in p.c., huh? Might as well ~~stare~~ stay there with the rest of the whiners. I'm on a regular yard since I figured if someone wants to dance I love to tango and would much rather die at the hands of a con than to hide in my cell or on a p.c. yard for the rest of my life. It's okay for alot of guys, not for me. I even made a bet with my bro that you'll come and hide behind your bible until you feel safe there and then you'll toss the bible to the side. I've seen dozens of guys just like you do that. Well, there you have it. I've said what I have to say to you. If you've got a problem with all or what I've had to say then I'm on yard #1. Come on out and I'll give ya the first shot. There's no getting around that cna so you will be coming up here. I sincerely suggest you null your actions over and crack yourself in the jaw for even writing such a suspicious letter in the first place. I'm done with what I've had to say. See you when you get here.

Enjoy the rice!

Robert

51

I WROTE ROBERT FOR INFORMATION ABOUT THIS CASE THIS LETTER IS FROM ROBERT EDWARDS

# EXHIBIT COVER PAGE

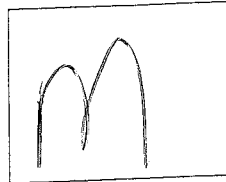

EXHIBIT

DESCRIPTION OF THIS EXHIBIT:

NUMBER OF PAGES TO THIS EXHIBIT: 3 PAGES

JURISDICTION: (CHECK ONLY ONE)

MUNICIPAL COURT

SUPERIOR COURT

APPELLATE COURT

STATE SUPREME COURT

UNITED STATES DISTRICT COURT

STATE CIRCUIT COURT

UNITED STATES SUPREME COURT

GRAND JURY



12+

12/13



Fred Holbrook Jr. (1996)

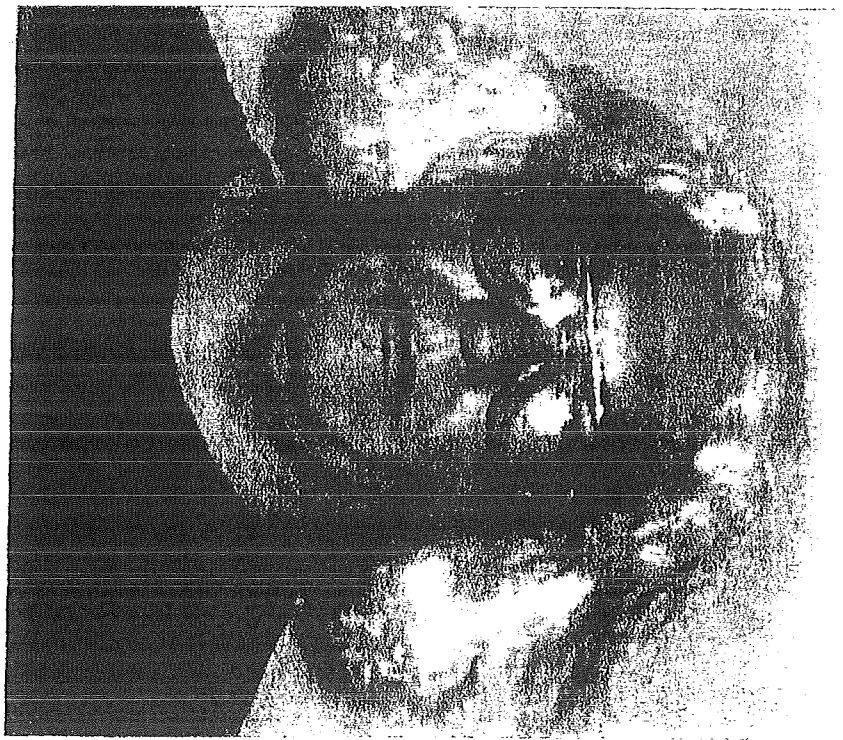

Fred Holbrook Jr. (2008)

(M)

12+

12/15



Fred Holbrook Sr. (1993)



Fred Holbrook Sr. (2008)

(12)

12+

County of San Bernardino  
California  
CA 03600

12/13

DR 1331036-07

REPORT AREA

SECTION P.C. 187	CRIME MURDER	CLASSIFICATION		
VICTIM'S NAME - LAST NAME COBB,		FIRST NAME RITA	MIDDLE NAME	(FIRM NAME IF BUSINESS)
ADDRESS 35435 Hwy. 18, Lucerne Valley		<input type="checkbox"/> RESIDENCE	<input type="checkbox"/> BUSINESS	PHONE ( )

INTERVIEW:

HALBROOK, Fred (Moose Lodge bartender; work phone: 248-6164)

On 9/26/85, at approximately 1300 hrs., contact was made with Mr. Halbrook at the Moose Lodge building in Lucerne Valley. At that time, Mr. Halbrook stated that the last time that he had seen Mrs. Cobb was on Wednesday, 9/18, and at that time she was alone. Mr Halbrook went on to say that he had heard from other people in the bar that Mrs. Cobb had been seen involved in an argument at the Zodiac bar on Friday night prior to the discovery of her body. Mr. Halbrook stated that the persons who told him about the fight described the argument as being with a male subject, but Mr. Halbrook could not remember who had told him the story.

REPORTING OFFICERS MC COY, Det. M-1384	DATE 9/27/85	REVIEWED BY	TYPED BY pk K-1179	ROUTED BY	DATE
ACTION: YES <input type="checkbox"/> NO <input type="checkbox"/>		COPIES TO: <input type="checkbox"/> Detective <input type="checkbox"/> Dist. Atty.	<input type="checkbox"/> SD/PD <input type="checkbox"/> CII <input type="checkbox"/> Patrol	<input type="checkbox"/> Other <input type="checkbox"/> Other	
REMARKS					

# EXHIBIT COVER PAGE

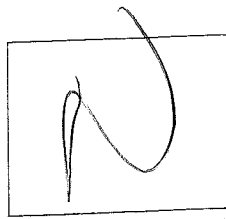

EXHIBIT

DESCRIPTION OF THIS EXHIBIT:

NUMBER OF PAGES TO THIS EXHIBIT: 4 PAGES

JURISDICTION: (CHECK ONLY ONE)

MUNICIPAL COURT

SUPERIOR COURT

APPELLATE COURT

STATE SUPREME COURT

UNITED STATES DISTRICT COURT

STATE CIRCUIT COURT

UNITED STATES SUPREME COURT

GRAND JURY

THIS TO BE PLACED BETWEEN PAGE 15 AND 16

124

199

SUPERIOR COURT OF CALIFORNIA, COUNTY OF SAN BERNARDINO  
VICTORVILLE DISTRICT  
MINUTE ORDER

CASE NO: FVI900518

DATE: 02/03/11

CASE TITLE: PEOPLE OF THE STATE OF CALIFORNIA  
vs.  
JOHN HENRY YABLONSKY

DEPT: V2 02/03/11 TIME: 9:00 am JURY TRIAL (DELIBERATIONS)

CHARGES: 1) 187(A) PC-F

JOHN M TOMBERLIN, JUDGE  
Clerk: Vickie Lo Vasco  
Certified Court Reporter: Shawna Manning; CSR# 12827  
Deputy District Attorney JOHN THOMAS present.  
Deputy Public Defender DAVE SANDERS present  
Deputy Public Defender PHIL ZYWICIEL (PM) present  
Defendant present in custody.

PROCEEDINGS  
Action came on for Jury Trial-In Progress

11TH DAY OF TRIAL.

9:10  
Jury RESUME deliberations 9:10.

10:47  
Recess declared 10:47

11:09  
Jury RESUMES deliberations 11:09.

Recess declared FOR JURORS - 12:00

13:30  
Jury RESUME deliberations 1:30.

Recess declared FOR JURORS - 3:22

15:50  
Jury RESUME deliberations 3:50.

16:35  
Court reconvenes; all parties present.

How IS THIS 30 MIN  
AND NOT PREJUDICIAL  
AND AN ATTORNEY IVE NEVER  
MET NOT PREJUDICE MY  
CASE WHO WAS THIS MAN  
THIS ATTORNEY STOOD IN  
WHEN SANDERS WAS DEADLOCKED  
AND SANDERS WAS IN  
COURT UNTIL 3 PM. MY  
FAMILY AS THE WANTED  
HALLWAY AS THE WANTED  
FOR JURY. IVE NEVER  
THIS ATTORNEY OR SPOKE TO  
MET SEEN OF YET HE  
NOW HEARD OF AUTHORITY IN  
HAD MY TRIAL  
97 MINUTES LATER

STILL DEAD LOCKED

STILL DEAD LOCKED 51 MINUTES LATER

STILL DEAD LOCKED 112 MINUTES LATER

AFTER THREE MORE DEAD  
LOCKS A VERDICT WAS FORCED

173

# TRIAL STARTS FOR 1985 L.V. MURDER

BY TOMOYA SHIMURA  
STAFF WRITER

**VICTORVILLE** • Daryl Kraemer walked inside his mother's Lucerne Valley home and smelled "something dead," almost like a septic tank, in an unusually hot house.

It was a quiet September morning except for the blaring music from a radio,

Kraemer looked inside a bedroom, and there he saw his 55-year-old mother, decomposing and naked on her bed. He cried and screamed and ran out of the house. Looking up at the sky, he yelled, "Why?"

Kraemer relived that moment more than 25 years later on Monday as he testified in the jury trial of John Yablonsky, who is accused

of strangling Rita M. Cobb to death with a wire coat hanger.

"I just went crazy in shock," Kraemer told jurors about discovering his dead mother on Sept. 23, 1985. Across from him in a Victorville courtroom sat the 47-year-old defendant dressed in a gray suit with a shaved head and glasses, diligently taking notes.

Yablonsky is charged with murder and special circumstances of rape or attempted rape. If convicted, he could face life in prison without parole.

Yablonsky wasn't arrested until March 2009, when San Bernardino County Sheriff's officials matched his DNA with evidence discovered at

SEE MURDER • PAGE 3

MY ATTORNEY WOULD'NT ASK QUESTIONS

Wednesday, January 26, 2011 | PAGE 3

## MURDER

FROM PAGE 1

the murder scene. The investigation took so long because DNA science was still in its infancy in 1985.

During the interview with detectives, Yablonsky recognized Cobb in a photo lineup.

He and his family used to rent Cobb's back house until they moved out about a year before her death. Yablonsky, 21 years old at the time, still lived close to Cobb's house in the 35400 block of Highway 18.

But Yablonsky denied ever having an intimate

relationship with the victim. His attorney, Deputy Public Defender David Sanders, reserved his opening statement for later in the trial.

Investigators found no signs of robbery at the crime scene. Cobb had her jewelry on and her purse was in plain sight.

Kraemer said when he first saw his mother's body, he had no idea she had been murdered. He thought she killed herself because she had been so lonely and despondent.

"I don't believe I ever touched her body," Kraemer said. "I wanted to reach out to her and hold her but I just couldn't do it."

I HAD TO FORCE HIM TO ASK VIRTUALLY EVERY QUESTION AND STILL HE REFUSED TO CHALLENGE THE PERJURING WITNESSES

THE BODY WAS MOVED SETTLMENT STONES THIS LEVITY

PHOTOS

THE COPS SHOWED ME A SINGLE PIC OF RITA NO LINEUP AND JUST BECAUSE I RECOGNIZED HER DOESNT MEAN I KILLED HER

128  
role  
203  
motive  
had no  
and in  
had bee

3 EACH

# HIGH DESERT

SECTION B • TUESDAY, FEBRUARY 1, 2011 • VICTOR VALLEY & THE HIGH DESERT

## Closing arguments heard in 1985 murder case

### Man accused of raping, strangling V. woman to death

BY NATASHA LINDSTROM  
STAFF WRITER

VICTORVILLE • DNA evidence suggesting John Yablonsky had sex with a Victor Valley woman shortly before she was killed some 25 years ago doesn't prove Yablonsky also murdered the woman, the defense argued Monday in Victorville court. Yablonsky, 47, is accused

of raping and strangling 55-year-old Rita M. Cobb to death with a wire coat hanger in her Lucerne Valley home in 1985. He is charged with murder and the special circumstance of rape or attempted rape.

In his closing argument, Deputy Public Defender Dave Sanders said the prosecution's evidence didn't directly link his client to the murder and suggested multiple other scenarios that could have led to her death.



DAILY PRESS FILE PHOTO  
**IN COURT:** Cold case murder defendant John Yablonsky, 47, right, talks with Deputy Public Defender David Sanders in in this recent file photo.

SEE YABLONSKY • PAGE 5

1 1/2 TO 5 DAYS BEFORE THE MURDER !!

FROM PAGE 1

Sanders argued the prosecution hadn't proved someone forced upon Cobb — a doctor testified there wasn't any physical evidence of a sexual assault — nor that the sexual act happened the same time as the strangulation. An expert testified Cobb could have had sex several hours or more than a day before she was killed. "The information we have in this case could add to a number of confusions," Sanders told jurors, reminding them that when there's multiple reasonable circumstances, "you must accept the one that points to innocence." Among the alterna-

before her death, over to her home to make a repair and the two had consensual sex. A man whom Cobb had reportedly been on a date with the suspected night of her death, Joe Saunders, was waiting outside and then entered her unlocked home and killed her in a jealous rage.

After the hearing, Sanders said sheriff's officials had confirmed Saunders committed suicide a few months after Cobb's death, but Sanders wasn't able to submit that finding to the jury.

"I couldn't figure out a way to get it in with the rules of evidence," Sanders said. "The only way you can get something in is with a live witness or someone that can

Deputy District Attorney John Thomas dismissed Sanders' alternative situations as imaginative plots not backed by any evidence.

"There has not been any evidence presented in this case that links this crime to anybody else but the defendant," Thomas told jurors.

Thomas argued there was evidence showing signs of a rape struggle and reminded jurors Cobb was found dead fully nude in a sexual position. *BODY MEXICO*

Thomas also replayed tape recordings of multiple interviews between the defendant and detectives in which Yablonsky repeatedly denied having sex with the victim — a finding Thomas said showed Yablonsky was

Sanders said was interviewed with his wife in the room, may have lied for fear of embarrassment that he slept with a woman double his age just before somebody killed her.

Many who would have been Cobb's contemporaries at the time of her death now can't be found or have died, and the prosecution has not reexamined the full list of 16 suspects initially brought in for questioning, Sanders added.

"We're ... trying to put a puzzle together where all we know is one or two little pieces," Sanders said. "Everything about it is circumstantial evidence. There is no direct evidence in this case that goes to the main issues." The prosecution

assault was the motive, as Cobb's home had not been ransacked and no items of value had been stolen.

Yablonsky opted not to testify. Just before he finished his closing, Sanders reminded jurors they could not use the fact that Yablonsky used his constitutional right not to testify as evidence of his guilt.

After jurors retired to deliberate, Sanders said he was confident the prosecution's evidence was so "spotty" that he didn't think any jury could "come back with a sure verdict."

If convicted, Yablonsky faces a maximum sentence of life in prison without the possibility of parole.

ed not t  
e he fir  
Sander  
es the  
he fac  
ised hi  
nt not t  
e of hi  
retire  
sander  
dent th  
videnc  
that h  
ny jur  
k with  
ablonsk  
m: ser  
n: riso

ole

# Yablonsky convicted

BY TOMOYA SHIMURA  
STAFF WRITER

**VICTORVILLE** • John Yablonsky, charged with the 1985 murder of a Lucerne Valley woman, was convicted last Thursday afternoon in Victorville Superior Court.

After three days of deliberations, a jury came back with the verdict finding Yablonsky guilty of the murder of Rita M. Cobb and special circumstances of rape. The 47-year-old defendant is expected to be sentenced to life in prison without

SEE CONVICTED • PAGE 8

## CONVICTED

FROM PAGE 1

parole on April 8.

The jurors almost hung Wednesday night — eight for guilty and four for not guilty. But Judge John Tomberlin told them to continue deliberating one more day.

Hearing the guilty verdict, Daryl Kraemer, the victim's son who was sitting in the audience with his wife, quietly wiped away tears. "It's just a joy,"

Kraemer said. "The jurors made the right decision."

Kraemer thanked the jurors in the court hallway and a male juror told him, "I hope it brings peace to your family."

Kraemer and his wife, Marta, discovered Cobb naked on her bed in her house more than 25 years ago. The victim had been strangled to death with a wire coat hanger.

Yablonsky wasn't arrested until March 2009, when San Bernardino County

Sheriff's officials matched his DNA with evidence discovered at the murder scene. The investigation took so long because DNA science was still in its infancy in 1985.

Some jurors told attorneys in the hallway it took them a while to reach the verdict because they felt they needed more evidence.

"I'm disappointed because I thought we had good evidence," said Deputy Public Defender Dave Sanders,

Yablonsky's attorney. "I thought there was serious reasonable doubt concerning my client's guilt. I felt it wasn't entirely clear what happened 25 years ago."

Cold cases can be difficult to try because witnesses from decades earlier can't be found, and evidence sometimes inadvertently gets lost or destroyed, Deputy District Attorney John Thomas said.

"I'm just happy they came back with a guilty verdict," Thomas said.

"I hope it gives some closure to Daryl and Marta."

During the interview with detectives, Yablonsky recognized Cobb in a photo. He and his family used to rent Cobb's back house until they moved out about a year before her death. Yablonsky repeatedly denied ever having a personal or sexual relationship with the victim during the interview with detectives. Because Yablonsky's DNA was found on Cobb,

some jurors said they like Yablonsky was 17 "Twenty-five year

guessing and think about what I could have done to change that at that time. It made me feel miserable," Kraemer said.

He was asked if the verdict helped ease the burden.

"Now I can start working on it," Kraemer said.

Tomooya Shimura may be reached at [tshimura@VVDailyPress.com](mailto:tshimura@VVDailyPress.com) or (760) 955-5868.



# EXHIBIT COVER PAGE

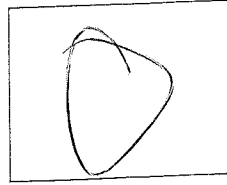

EXHIBIT

DESCRIPTION OF THIS EXHIBIT:

NUMBER OF PAGES TO THIS EXHIBIT: 2 PAGES

JURISDICTION: (CHECK ONLY ONE)

- MUNICIPAL COURT
- SUPERIOR COURT
- APPELLATE COURT
- STATE SUPREME COURT
- UNITED STATES DISTRICT COURT
- STATE CIRCUIT COURT
- UNITED STATES SUPREME COURT
- GRAND JURY

Melody Wittenberg  
1700 E. Silva st.  
L.B., Ca. 90807

TO WHOM THIS LETTER CONCERNS:

I WAS JOHNS' WIFE DURING HIS TRIAL AND THE MONTHS /YEARS PRIOR TO HIS TRIAL, THAT HE WAS STANDING AWAIT FOR HIS TRIAL TO BEGIN AND HAD ATTENDED SEVERAL OF HIS COURT APPEARANCES, SPEAKING TO HIS ATTORNEY DAVE SANDERS. JOHN HAD GIVEN SANDERS PERMISSION FOR HIS ATTORNEY TO SPEAK WITH ME IN FULL AND COMPLETELY HONEST. DAVE SANDERS HAD TOLD ME THERE WAS NO EVIDENCE THAT JOHN HAD COMMITTED THIS CRIME AND THAT HE WAS PREPARING FOR TRIAL THROUGH INVESTIGATIONS. I TOOK THE LIBERTY TO COLLECT SEVERAL LETTERS OF CHARACTER REFERENCES FOR JOHN, AND HAD GIVEN THEM TO MR. SANDERS PERSONALLY MYSELF. OF THE LETTERS WAS SOME FROM BUISNESS ASSOCIATES IN THE NEIGHBORING COUNTIES THAT JOHN HAD DONE ALOT OF WORK WITH OVER THE YEARS THAT WERE DEVELOPERS AND I WAS EVEN ABLE TO GATHER SOME FROM HIS LONG TIME CUSTOMERS AND FRIENDS FROM OVER THE YEARS, THERE WAS ABOUT TWELVE OF THEM.

ON SEVERAL OCCAISIONS I HAD DISCUSSED WITH SANDERS ABOUT HIS DEFENSE FOR JOHN AND HAD ASKED IF THERE WAS ANYTHING THAT I COULD DO IN ORDER TO HELP MY HUSBAND AND HIS DEFENSE IN ANY WAY AND WAS TOLD THAT HE HAD EVERYTHING UNDER CONTROL. ON THE DAY WHEN THE JURY RETURNED I HAD SEEN SANDERS IN THE HALLWAY LINGERING ABOUT AND WAS UPSET THAT WHEN THEY BROUGHT JOHN IN THE COURT ROOM THAT SANDERS WAS NOT THERE AND THAT THERE WAS SOME OTHER ATTORNEY THAT WE HAD NEVER SEEN. THE JURY ANNOUNCED THAT THEY WERE HOPELESSLY DEADLOCKED AND THE JUDGE ASKED THEM TO DELIBERATE FOR JUST ONLY 30 MORE MINUTES THE FOLLOWING DAY. AT THE END OF THE NEXT DAY AFTER THE JURY WAS FORCED TO DELIBERATE FOR 7 HOURS, AND AGAIN WHEN THE JURY RETURNED SANDERS WAS NOT IN THE COURT ROOM AND WAS NOWHERE TO BE FOUND. I WAS UNDER THE IMPRESSION THAT MR. SANDERS WAS A SPECIALIST AS A TRIAL LITIGATOR FOR MURDER TRIALS, YET WHEN THE WITNESSES TESTIFIED FALSELY HE DID NOTHING TO CHALLENGE THEM OR CORRECT THEIR TESTIMONIES. THIS LETTER WAS WRITTEN UNDER THE PENALTY OF PERJURY AND IS TRUTHFUL TO THE BEST OF MY KNOWLEDGE.

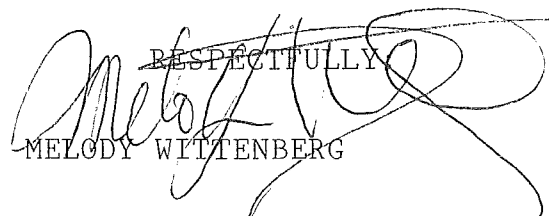
RESPECTFULLY  
  
MELODY WITTENBERG

GEORGE YABLONSKY  
BOX 517  
LUCERNEVALLEY, CA.92356

DECLARATION MADE UNDER THE PENALTY  
OF PERJURY

To whom this concerns;

I am the father of John Yablonsky, and I met his attorney Dave Sanders as soon as he was assigned to represent John. I was informed that John had given Mr Sanders authority to discuss all matters with regards to the preperation and the defense of my son.

I was told by Mr. Sanders that there was no evidence that John had committed any crimes that he was being tried for, and that he had in fact had a plan of defending my son, and that he was in fact a specialist in murder litigation and that was primarily all he in fact did was fight murder cases, and had since 1982.

I attended every court appearance of Johns, and every time I spoke at great lengths with Mr. Sanders he assured me that he had in fact prepared an extensive list of defenses that would allow him to challenge the states evidence and witnesses, that basically amounted to nothing since there really wasn't any thing that showed that John had committed any crimes. All this was continually related to me from Mr. Sanders at just about every court hearing.

I was beyond suprised that I noticed that Mr. Sanders was continually representing other defendants for various charges such as public intoxication, drug charges, and a variety of misdemeanor charges, while I was told repeatedly that he was a specialist in murder litigation, and that he at one time discussed to me that he had in fact only had 6 actual hours to prepare for the trial that my son was getting ready to begin. I myself had read alot of the discovery that my son had relayed to me, and was sincerely disturbed when during the trial several of the witnesses had testified differently than their previous reports to the police and that Mr. Sanders did not object, or even challenge their perjuring testimonies, and the most disturbing was when the jury returned hoplessly deadlocked the Sanders wasn't even there nor was he there when the verdict came in, especially when just minutes before Sanders was in the hallway. How did this man get his license to defend people that are counting on a defense?

Respectfully;

# EXHIBIT COVER PAGE



EXHIBIT

DESCRIPTION OF THIS EXHIBIT:

NUMBER OF PAGES TO THIS EXHIBIT: 29 PAGES

JURISDICTION: (CHECK ONLY ONE)

MUNICIPAL COURT

SUPERIOR COURT

APPELLATE COURT

STATE SUPREME COURT

UNITED STATES DISTRICT COURT

STATE CIRCUIT COURT

UNITED STATES SUPREME COURT

GRAND JURY

281  
103

178

Law Offices of the Public Defender



SAN BERNARDINO COUNTY

Doreen B. Boxer  
Public Defender

LOOK AT SEQUENCE OF  
TIME November 2, 2009 TO NOV. 10, 2009

Blain Kern  
440 Business Center Court  
Redlands, CA 92373

HE KNOW THE SEVERAL DNA'S  
FOR OVER 2 YEARS

Re: People v Yablonski

Dear Mr. Kern:

I would like to discuss with you the possibility of retaining your services in helping me to represent my client John Yablonski. He was arrested in January of this year for the murder of Rita Cobb in September of 1985. This matter arises at this late date due to an alleged match in DNA between a swab taken this year when Mr. Yablonski was arrested in Long Beach and evidence that was reportedly collected at the scene of the crime in 1985 in the Lucerne Valley.

At this point I need an approximation of the costs of employing your services. I have attached a number of lab reports which the police and the DA are using to make their case. I need to know if there is any avenue of attack based on the manner in which the evidence was collected and tested by the authorities.

Please contact me at your earliest convenience regarding this matter.

Sincerely,

David Sanders  
Deputy Public Defender

A

HE WAS GONNA  
TRY TO TEST  
MY DNA  
BUT NOT  
RED HAIR?  
OR  
CIGARETTEE BUTTS?

SANDERS FIRST  
REQUEST TO FIND BILLING OF DNA TEST  
BUT NOTHING TO FOLLOW UP OR  
SECURE THIS REQUEST

282  
104

179

b6



# HUMAN IDENTIFICATION TECHNOLOGIES, INC. HITDNA.COM

November 10, 2009

Estimate Prepared For:  
David Sanders  
Deputy Public Defender  
14344 Cajon Ave, Suite 201  
Victorville, CA 92392  
Phone: (760) 241-0413  
Fax:  
Email: dsanders@pd.sbcounty.gov

Prepared By:  
Blaine Kern  
Human Identification Technologies, Inc.  
440 Business Center Court  
Redlands, CA 92373  
Phone: (909) 557-1828  
Fax: (909) 557-1831  
Federal Tax ID No. 26-2285633

Re: Estimate & Engagement Letter for Consultation (People v. Yablonski)

Mr. Sanders,

Thank you for contacting Human Identification Technologies, Inc. (HIT) regarding your DNA consultation needs. Based on our review of the laboratory reports mailed to our laboratory, we estimate it will require 11 to 14 hours to thoroughly review all of the laboratory notes, data, statistics, reports, protocols, procedures and guidelines, etc. associated with this case. The following is a breakdown of the hours required to review this case.

**Summary of case review hours required:**

*AS*

- Review of DNA reports and statistics:
- Review of analytical bench notes:
- Review of DNA protocols:
- Review of DNA electronic data:

	<u>Initials</u>
2-3 hours	_____
3-4 hours	_____
2 hours	<u>Mandatory</u>
4-5 hours	_____
11 to 14 hours	

Total Hours:

The quote has been broken down so that you may choose to focus your resources on the areas you deem most critical. Please place your initials next to the services you require. Our current hourly rates are presented below and are based upon desired turn around time. Please place your initials next to the turn around time you require.

<u>10 business day turn around</u> time*/\$300 per hour	<u>10-20 business day turn</u> around time*/\$275 per hour	<u>20+ business day turn around</u> time*/\$250 per hour
--	---	---

\*Turn around time begins on the date that all discovery materials are received by Human Identification Technologies, Inc.

440 BUSINESS CENTER COURT, REDLANDS, CA 92373

P: 909-557-1828 F: 909-557-1831

THIS WAS A REQUEST THAT WAS NOT SUBMITTED BY SANDER TO APPROVE HIS INITIAL REQUEST

283  
105  
180

67

In the event that additional consulting/testimony services are requested by the client, the same per hour rate quoted herein will apply, and a new estimate may be prepared. Appropriate travel costs will apply. Please refer to our fee schedule for other potential costs associated with our services. The current fee schedule can be viewed or downloaded at [www.hitdna.com/consulting.htm](http://www.hitdna.com/consulting.htm).

If this case is dismissed after discovery is requested by HIT but prior to any case review being performed, then an administration fee of two consulting hours will be charged. You have the right to terminate your relationship with us at anytime. This may occur if our consultation is no longer required for some unforeseen reason. Notwithstanding this scenario, you will be obligated to pay all costs incurred prior thereto.

Please excuse the formal and mechanical nature of this letter. It is a necessary step to ensure that the nature of our business relationship is clearly understood.

Please feel free to contact me with any questions or concerns you might have regarding this letter. I am looking forward to ensuring that "Genetic Justice™" is being served in this case!

Sincerely,

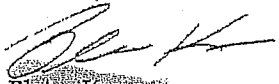

Blaine Kern  
President/Forensic Scientist  
Human Identification Technologies, Inc.  
b.kern@hitdna.com.com  
(909) 557-1828

*SANDERS NEVER  
TRIED TO TEST DNA  
B*

This is to confirm my understanding and acceptance of the terms set forth in this engagement letter as well as my receipt of Human Identification Technologies, Inc.'s 'Fee Schedule (s)'.

Dated: \_\_\_\_\_

Signature: \_\_\_\_\_

Printed Name: \_\_\_\_\_

Please execute a copy of this letter and return to us. You can fax it to us at (909) 557-1831. We will also need to be provided with a 'wet-signature' copy for our records. Our mailing address is 440 Business Center Court, Redlands, California 92373.

Comparison between 44452 Q hairs and 44659 Q hairs

44452

A-5 (10/1 mounts)

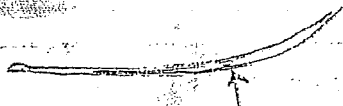
- reddish brown hair 15 cm long
- roots 
- pigment - none at roots, gradually increases to between light medium and medium, diminishes at tip
- medulla - very characteristic 

A-6 (2 mounts)

- dia visibly > than 44659 h.1

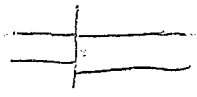

abrupt cut-off (all 3 hairs)

44659

A-1 (1)

- reddish brown hair 14 cm long
- root 
- pigment - none at root, gradually increases to medium density, diminishes at tip
- medulla - continuous ~~throughout~~, fragmented, extends to tip

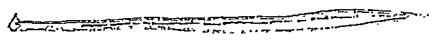

- can not link these; may just need a larger population of hairs



Mixture SAMPLE: PRODUCT	Mutation: LR 44659 A-18a E1 female		Selected Genotype													
	1/PRODUCT	2/PRODUCT	Amelogeni	D6S1179	D21S11	D18S51	D3S1358	vWA	FGA	D5S818	D13S317	D7S820	TH01	TPOX	CSF1PO	D16S539
1.09E-13	9.18E+12	(FBI-African-American)	X	12,15	0	13,14	0	15,17	0	21,26	11,11	12,14	0	0	11,12	12,13
1.33E-12	7.53E+11	(FBI-Caucasian)	*	15,15	0	0	0	0	0	24,26	0	0	0	0	11,11	12,13
5.01E-12	2.00E+11	(FBI-SW Hispanic)		0	0	0	0	0	0	26,26	0	0	0	0	0	0
1.17E-13	8.56E+12	(SERI-African-American)		0	0	0	0	0	0	0	0	0	0	0	0	0
1.13E-12	8.87E+11	(SERI-CAUCASIAN)		0	0	0	0	0	0	0	0	0	0	0	0	0
4.68E-12	2.14E+11	(SERI-SW Hispanic)		0	0	0	0	0	0	0	0	0	0	0	0	0
1.29E-13	7.73E+12	(CAL-African American)		0	0	0	0	0	0	0	0	0	0	0	0	0
1.41E-12	7.09E+11	(CAL-Caucasian)		0	0	0	0	0	0	0	0	0	0	0	0	0
2.64E-12	3.78E+11	(CAL-SW Hispanic)		0	0	0	0	0	0	0	0	0	0	0	0	0
1.28E-12	7.79E+11	(Cal-CHINESE)		0	0	0	0	0	0	0	0	0	0	0	0	0
1.77E-12	5.66E+11	(CAL-JAPANESE)		0	0	0	0	0	0	0	0	0	0	0	0	0
6.81E-13	1.47E+12	(CAL-Korean)		0	0	0	0	0	0	0	0	0	0	0	0	0
2.84E-13	3.52E+12	(SP-Vietnamese)		0	0	0	0	0	0	0	0	0	0	0	0	0
1.95E-13	5.13E+12	(AZ-DPS-Apache)		29	0	0	0	0	0	0	0	13	0	0	0	0
1.33E-12	7.51E+11	(AZ-DPS-Navajo)		0	0	0	0	0	0	0	0	0	0	0	0	0

CP1 METHOD/Alleles

Calculations:  
 (FBI data from J. Forensic Sci., {1999}, 44(6), 1277-1286)  
 Minimum allele freq: 5/2N  
 Theta (θ) = 0.01  
 (CAL, ISP, AZ-DPS data from J. Forensic Sci., 2001:46(3):453-48; Familial (F) = 0)

**MUST SEE**  
 2ND READ  
 2-1 = 12  
 D8S1179 CHART  
 THIS SHOWS AFRICAN A/A  
 12/16/09

D18S51  
 2-1 = 1318 CHART  
 THIS SHOWS SA 1314  
 1314  
 PROTOCOL

Mixture Calculation: LR 44659 A-18b E1 female Selected Genotype

Amelogenin	D8S1179	D21S11	D18S51	D3S1358	WVA	FGA	D5S818	D13S317	D7S820	TH01	TPOX	CSF1PO	D18S539
7.35E-11	12,15	0	13,14	16,17	0	0	0	0	0	0	0	0	0
1.50E-10	15,15	0	0	0	0	0	0	0	0	0	0	0	0
6.23E+09		0	0	0	0	0	0	0	0	0	0	0	0
6.57E-10		0	0	0	0	0	0	0	0	0	0	0	0
1.17E+08		0	0	0	0	0	0	0	0	0	0	0	0
9.09E-11		0	0	0	0	0	0	0	0	0	0	0	0
1.10E+10		0	0	0	0	0	0	0	0	0	0	0	0
4.56E+09		0	0	0	0	0	0	0	0	0	0	0	0
2.19E-10		0	0	0	0	0	0	0	0	0	0	0	0
4.59E-10		0	0	0	0	0	0	0	0	0	0	0	0
2.18E+09		0	0	0	0	0	0	0	0	0	0	0	0
6.89E-11		0	0	0	0	0	0	0	0	0	0	0	0
1.45E+10		0	0	0	0	0	0	0	0	0	0	0	0
2.35E-10		0	0	0	0	0	0	0	0	0	0	0	0
4.23E+09		0	0	0	0	0	0	0	0	0	0	0	0
3.89E-10		0	0	0	0	0	0	0	0	0	0	0	0
2.57E+09		0	0	0	0	0	0	0	0	0	0	0	0
3.24E-10		0	0	0	0	0	0	0	0	0	0	0	0
3.09E+09		0	0	0	0	0	0	0	0	0	0	0	0
3.56E-10		0	0	0	0	0	0	0	0	0	0	0	0
2.73E+09		0	0	0	0	0	0	0	0	0	0	0	0
1.47E-10		0	0	0	0	0	0	0	0	0	0	0	0
7.11E+09		0	0	0	0	0	0	0	0	0	0	0	0
8.07E-11		0	0	0	0	0	0	0	0	0	0	0	0
1.24E+10		0	0	0	0	0	0	0	0	0	0	0	0
1.39E-11		29											
7.17E+10													
1.80E+10													
1.80E+10													

Population Data: (FBI data from J. Forensic Sci., (1999), 44(6), 1277-1286) (SERI data from CAC Seminar, 1998 and 1999) (CAL, ISP, AZ-DPS data from J. Forensic Sci., 2001:45(3):453-48; Familial (F)=

Calculations: Minimum allele freq: 5/2N 0.01 0 Theta (q)= 0 Unrelated, heterozygous: P= 2pip Unrelated, unilineal, heterozygous: P=pip2+p(1-p)q Related, bilineal, heterozy P=(1+2pi+pi2)/4 Related, unilineal, homozy P=pip2+4p(1-p)F

DX 7/2/09

LR \_\_\_\_\_ Analyst \_\_\_\_\_

LR

2nd Reads

COMPILED READS  
DKey

Item and Description	Amel	D8S1179	D21S11	D18S51	D3S1358	VWA	FGA	D5S818	D13S317	D7S820	TH01	TPOX	CSF1PO	D16S539
A-18a : non-sperm fraction, assuming male from sperm fraction is present	X	12, 15 or 15	has 29	13, 14	16, 17	has 17	21, 26 or 24, 26 or 26	11	12, 14	has 13	any	8, 11 or 11	11, 12 or 12	12, 13 or 13
A-18b: non-sperm fraction, assuming male from sperm fraction is present	X	12, 15 or 15	has 29	13, 14	16, 17	any	has 26	any	12, 14	has 13	any	8, 11 or 11	has 12	11, 13 or 13

TABLE I

D8S1179

J-1 = 12

A-11 = 12, 15

A-11 = 12, 15 or 15? ASSUMING!

A-11 = 12, 15 or 15? ASSUMING!

AMEL

J-1 = X, Y

A-11 = X (ONLY)

D21S11

J-1 = 29, 30

A-11 = 29 ONLY

~~Starred scribble~~

D18S51  
J-1 = 13, 14  
A-11 = 13, 14

D3S1358  
J-1 = 15, 18  
A-11 = 16, 17

FGA  
J-1 = 21, 24  
A-11 = 21, 26

A-11 = 21, 26

VWA  
J-1 = 16, 17  
A-11 = 17

J-1 = 16, 17

A-11 = 17

D13S317  
J-1 = 9, 11, 14  
A-11 = 12, 14

D7S820  
J-1 = 10, 12  
A-11 = 10, 13

LR

2nd Reads

COMPARED READS  
DKEY

Table I: Profiler Plus STR Results for the Questioned and Reference Blood Samples

Item and Description	Amel	D8S1179	D21S11	D18S51	D3S1358	VWA	FGA	D5S818	D13S317	D7S820
A-18a : non-sperm fraction	X with weaker Y	12 with weaker 15	29 with weaker 30	13 with weaker 14, 18	15, 18 with weaker 16, 17	17 with weaker 16	21, 24 with weaker 26	11 with weaker 12	9, 11, 12, 14	10, 12, 13
A-18a: sperm fraction	X, Y	12	29, 30	13, 18	15, 18	16, 17	21, 24	11, 12	9, 11	10, 12
A-18b: non-sperm fraction	X with weaker Y	12 with weaker 15	29 with weaker 30	13 with weaker 18 with weak 14	15, 18 with weaker 16, 17	16, 17	21, 24 with weak 26	11, 12	9, 11 with weak 12, 14	10, 12 with weak 13
A-18b: sperm fraction	X, Y	12	29, 30	13, 18	15, 18	16, 17	21, 24	11, 12	9, 11	10, 12
A-11: non-sperm fraction from Rita Cobb's vaginal swab, previously examined, from report dated Jan. 13, 2003	X	12, 15	29	13, 14	16, 17	17	21, 25	11	12, 14	10, 13
J-1: Reference buccal swab from John H. Yablonsky	X, Y	12	29, 30	13, 18	15, 18	16, 17	21, 24	11, 12	9, 11	10, 12

Table II: Cofiler STR Results for the Questioned and Reference Blood Samples

Item and Description	Amel	TH01	TPOX	CSF1PO	D3S1358	D16S539	D7S820
A-18a : non-sperm fraction	X with weaker Y	7	8 with weaker 11	10, 11, 12	15, 18 with weaker 16, 17	11, 12 with weaker 13	10, 12, 13
A-18a: sperm fraction	X, Y	7	8	10, 11	15, 18 with weaker 17	11, 12	10, 12
A-18b: non-sperm fraction	X with weaker Y	7	8 with weaker 11	10, 11 with weak 12	15, 18 with weaker 16, 17	11, 12 with weaker 13	10, 12 with weak 13
A-18b: sperm fraction	X, Y	7	8	10, 11	15, 18	11, 12	10, 12
A-11: non-sperm fraction from Rita Cobb's vaginal swab, previously examined from report dated Jan. 13, 2003	X	7	8, 11	11, 12	16, 17	12, 13	10, 13
J-1: Reference buccal swab from John H. Yablonsky	X, Y	7	8	10, 11	15, 18	11, 12	10, 12

2nd Read  
44659 DK 7/2/09  
B 10/25

BC 096000071

TSME (6 1/2" x 9 1/2") mi

(2) TS coin env, markings similar to outside env.

1 env opened & E

(2) swabs, 1/2 of 1

sampled for analysis as J-1.

Reference Buccal Swabs  
John H. Yablonsky 09/30/1963. Suspect  
03/08/09 1315  
R. Alexander A1672  
San Bernardino Co. Sheriff's Dept  
DR# 1331036-07 H# 100-85

6/24/09

BC 9842018029

TSME (6 1/2" x 9") mi

44659 DNA extraction materials  
extracted substrate: A-18a, A-18b  
soluble proteins: A-18a, A-18b, reagent control  
slides: A-18a, A-18b  
slot blot membrane  
extracted DNA: A-11 (E1/E2) A-18a (E1/E2)  
A-18b (E1/E2) A-18 control (E1, E2)  
R.C. (E1, E2) C, E1, F, G-1, I  
extraction controls

Casework membrane

added 11-23-99

extracted DNA: A-23; A-23 control, A-24  
reagent control, extraction control,  
slot blot membrane

W/10  
SMA  
SHE/HE  
DID TESTIFY AT  
TRIAL

E. 5 TSCE; 1 SPL zip bag; (3) Kpakü membranes; (1) SSH; (1) DSH

TSCE [44659 extracted substrate] NE

TSCE [44659 soluble proteins] NE

TSCE [44659 extracted DNA reference samples] NE

TSCE [44659 extracted DNA] NE

JK  
12/09

BC 9842018029 cont...

TSCE [44659 extracted DNA evidential samples] = 10 pl vials

44659 RC E1 11-17-97 - NE

44659 RC E2 11-17-97 ~2ul NE

44659 A-11 E2 - NE

44659 A-11 E1 1/10 ~10ul NE

44659 A-11 E1 1/100 ~15ul NE

44659 A-18a E1 ~1ul → 10ul sterile water added

44659 A-18a E2 ~1ul → quanted using RT-PCR  
amp'd / typed in STRs

44659 A-18b E1 ~1ul →

44659 A-18b E2 - NE

44659 A-18b E2 1/10 ~10ul → quanted using RT-PCR  
amp'd / typed in STRs

TS pl zip bag [44659] = 7 pl vials

44659 A-11 E1 ~30ul NE

44659 A-11 E1 1/500 ~1500ul NE

44659 A-11 E1 1/100 ~500ul NE

44659 A-11 E2 1/10 ~5ul NE

44659 A-11 E2 1/100 ~1ul NE

44659 R.C. E1 ~1ul → SMA 6-24-09  
10ul sterile water added

44659 R.C. E2 ~2ul → quanted using RT-PCR  
amp'd / typed in STRs  
quanted using RT-PCR  
amp'd / typed in STRs

WORK  
UP  
BY  
SMA.?

DE  
7/2/09

IPC

VIC

0.200000

6

15

LR 44659

D4	RRC-6-23-09	Human IPC	Unknown Unknown	Undet. 26.37
E3	R.C. E1	Human IPC	Unknown Unknown	37.68
F3	R.C. E2	Human IPC	Unknown Unknown	26.38 Undet.
G3	RT Amp Neg	Human IPC	Unknown Unknown	26.43 Undet. 26.43

06/30/2009 778

Page 1 of 26

06-25-09-sma

DJC  
7/3/09

**GeneScan Injection Sheet "GeneScan Injection Sheet - Untitled-1"**

310 v3.1.0 - 4 Dye. Copyright 1999-2004 Applied Biosystems, Inc.

Page 1 of 1

	Tube + Sample Name	Module	Inj. Secs	Inj. kV	Run kV	Run Temp	Run Time	Matrix File	Auto Anlz	Analysis Parameters	Size Standard	Auto Prt
1	A1 - Formamide + RO	GS STR PO	5	15.	15.	60	26	Bogu	fals			fal
2	A1 - Formamide + RO	GS STR PO	5	15.	15.	60	26	Bogu	fals			fal
3	A7 - PP_AmpNeg_	GS STR PO	5	15.	15.	60	26	Bogu	fals			fal
4	A5 - PP 9947a	GS STR PO	5	15.	15.	60	26	Bogu	fals			fal
5	A3 - PP_Ladder_	GS STR PO	5	15.	15.	60	26	Bogu	fals			fal
6	A9 - PP 44659 A-18a	GS STR PO	5	15.	15.	60	26	Bogu	fals			fal
7	A11 - PP_44659_A-18	GS STR PO	5	15.	15.	60	26	Bogu	fals			fal
8	B2 - PP 44659 A-18b	GS STR PO	5	15.	15.	60	26	Bogu	fals			fal
9	B4 - PP_44659_A-18b	GS STR PO	5	15.	15.	60	26	Bogu	fals			fal
10	B6 - PP_RCE1	GS STR PO	5	15.	15.	60	26	Bogu	fals			fal
11	B8 - PP_RCE2	GS STR PO	5	15.	15.	60	26	Bogu	fals			fal
12	B10 - PP_RRC6-23-09	GS STR PO	5	15.	15.	60	26	Bogu	fals			fal
13	B12 - PP_96256_B-1_	GS STR PO	5	15.	15.	60	26	Bogu	fals			fal
14	C1 - PP 94085 D-1	GS STR PO	5	15.	15.	60	26	Bogu	fals			fal
15	C3 - PP_44659_J-1_	GS STR PO	5	15.	15.	60	26	Bogu	fals			fal
16	C5 - PP Ladder	GS STR PO	5	15.	15.	60	26	Bogu	fals			fal
17	A5 - PP_9947a_	GS STR PO	5	15.	15.	60	26	Bogu	fals			fal
18	A7 - PP_AmpNeg	GS STR PO	5	15.	15.	60	26	Bogu	fals			fal
19	C7 - CF_Ladder_	GS STR PO	5	15.	15.	60	26	Bogu	fals			fal
20	C9 - CF 9947a	GS STR PO	5	15.	15.	60	26	Bogu	fals			fal
21	C11 - CF_AmpNeg_	GS STR PO	5	15.	15.	60	26	Bogu	fals			fal
22	D2 - CF 44659 A-18a	GS STR PO	5	15.	15.	60	26	Bogu	fals			fal
23	D4 - CF_44659_A-18a	GS STR PO	5	15.	15.	60	26	Bogu	fals			fal
24	D6 - CF 44659 A-18b	GS STR PO	5	15.	15.	60	26	Bogu	fals			fal
25	D8 - CF_44659_A-18b	GS STR PO	5	15.	15.	60	26	Bogu	fals			fal
26	D10 - CF_RCE1	GS STR PO	5	15.	15.	60	26	Bogu	fals			fal
27	D12 - CF_RCE2	GS STR PO	5	15.	15.	60	26	Bogu	fals			fal
28	E1 - CF_RRC6-23-09	GS STR PO	5	15.	15.	60	26	Bogu	fals			fal
29	E3 - CF_96256_B-1_	GS STR PO	5	15.	15.	60	26	Bogu	fals			fal
30	E5 - CF 94085 D-1	GS STR PO	5	15.	15.	60	26	Bogu	fals			fal
31	E7 - CF_44659_J-1_	GS STR PO	5	15.	15.	60	26	Bogu	fals			fal
32	E9 - CF Ladder	GS STR PO	5	15.	15.	60	26	Bogu	fals			fal
33	C9 - CF_9947a_	GS STR PO	5	15.	15.	60	26	Bogu	fals			fal
34	C11 - CF_AmpNeg	GS STR PO	5	15.	15.	60	26	Bogu	fals			fal

**Inst # 3**

capillary VDB13R PP Ldr 0805008  
 polymer 0901167 CF Ldr 0802004  
 buffer 0902311 Formamide 0808747  
 ROX 0811486

Mon Jun 29 16:57:53 PDT 2009

- 1 -

3K  
7/2/09

*Handwritten signature*



Calculation Typ Single Source Genotype

Sample	LR 44659 A-18a E2 major / A-18b E2		Familial: Sibling - Bilineal		Entered Types	Locus	
	Unrelated		Product	1/Product			
FBI-African Amr	8.74E-17	1.14E+16	3.05E-06	3.28E+05		Amelogenin	Allele 1 XY
FBI-Caucasian	5.20E-15	1.92E+14	5.19E-06	1.93E+05			Allele 2
FBI-SW Hisp	3.07E-14	3.26E+13	8.35E-06	1.20E+05		D8S1179	Allele 1 12
							Allele 2 12
SERI-African Ar	1.17E-16	8.51E+15	3.05E-06	3.28E+05		D21S11	Allele 1 29
SERI-Caucasian	5.70E-15	1.75E+14	5.57E-06	1.79E+05			Allele 2 30
SERI-SW Hispai	2.13E-14	4.69E+13	7.12E-06	1.40E+05		D18S51	Allele 1 13
							Allele 2 18
CAL-African Arr	4.97E-17	2.01E+16	2.98E-06	3.35E+05		D3S1358	Allele 1 15
CAL-Caucasian	3.24E-15	3.08E+14	4.90E-06	2.04E+05			Allele 2 18
CAL-SW Hispan	2.57E-14	3.89E+13	7.16E-06	1.40E+05		vWA	Allele 1 16
							Allele 2 17
CAL-Chinese	4.32E-15	2.32E+14	5.26E-06	1.90E+05		FGA	Allele 1 21
CAL-Japanese	1.09E-15	9.19E+14	3.79E-06	2.64E+05			Allele 2 24
CAL-Korean	2.88E-15	3.48E+14	5.00E-06	2.00E+05		D5S818	Allele 1 11
							Allele 2 12
ISP-Vietnamese	1.68E-16	5.94E+15	3.13E-06	3.20E+05		D13S317	Allele 1 9
							Allele 2 11
AZ-DPS-Apache	4.74E-16	2.11E+15	6.72E-06	1.49E+05		D7S820	Allele 1 10
AZ-DPS-Navajo	3.87E-15	2.58E+14	1.23E-05	8.14E+04			Allele 2 12
						TH01	Allele 1 7
							Allele 2 7
						TPOX	Allele 1 8
							Allele 2 8
						CSF1PO	Allele 1 10
							Allele 2 11
						D16S539	Allele 1 11
							Allele 2 12

Population Data:

(FBI data from J. Forensic Sci., (1999), 44(6), 1277-1286)  
 (SERI data from CAC Seminar, 1998 and 1999)  
 (CAL, ISP, AZ-DPS data from J. Forensic Sci., 2001:46;(3):453-489)

Calculations:

Minimum allele freq: 5/2N  
 Theta (q)= 0.01  
 Familial (F)= 0

Unrelated, homozygous:  $P = \pi^2 + \pi(1-\pi)q$

Unrelated, heterozygous:  $P = 2\pi p_j$

Related, unilineal, homozygous:  $P = \pi^2 + 4\pi(1-\pi)F$

Related, unilineal, heterozygous:  $P = 2\pi p_j + 2(\pi + p_j - 4\pi p_j)F$

Related, bilineal, homozygous:  $P = (1 + 2\pi + \pi^2)/4$

Related, bilineal, heterozygous:  $P = (1 + \pi + p_j + 2\pi p_j)/4$

LR 44659

Analyst [Signature]

PAGE 24 OF 26

DK  
7/2/09

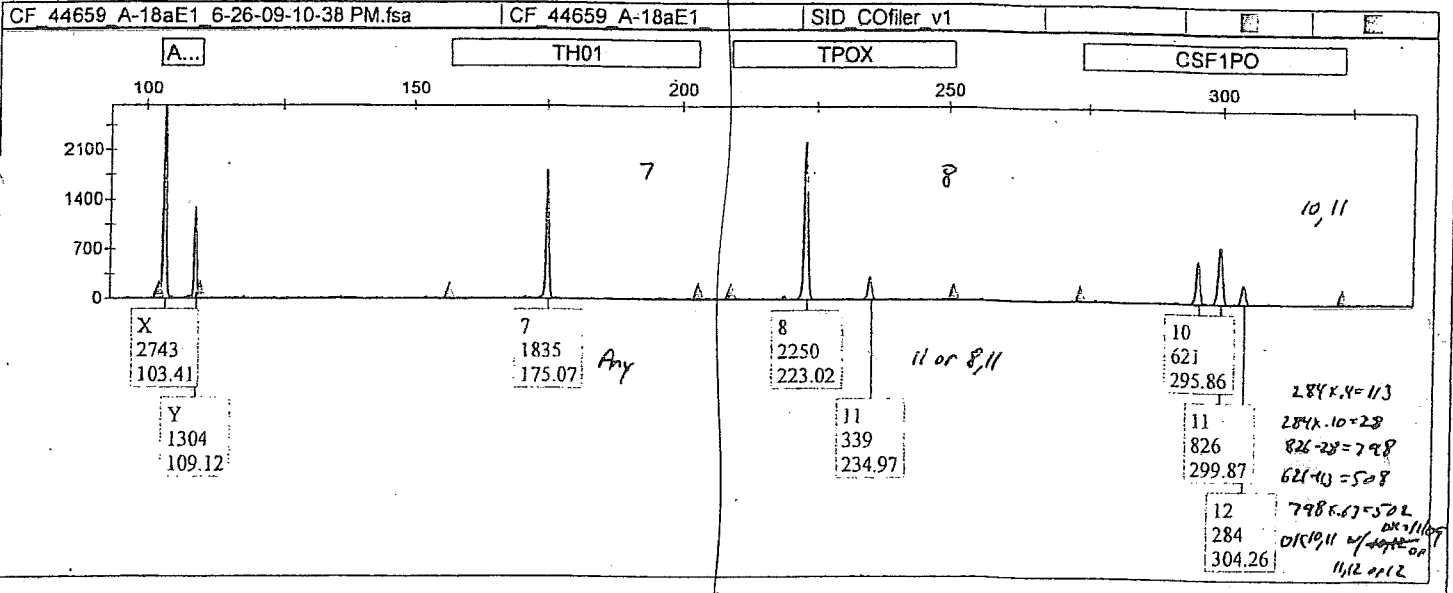
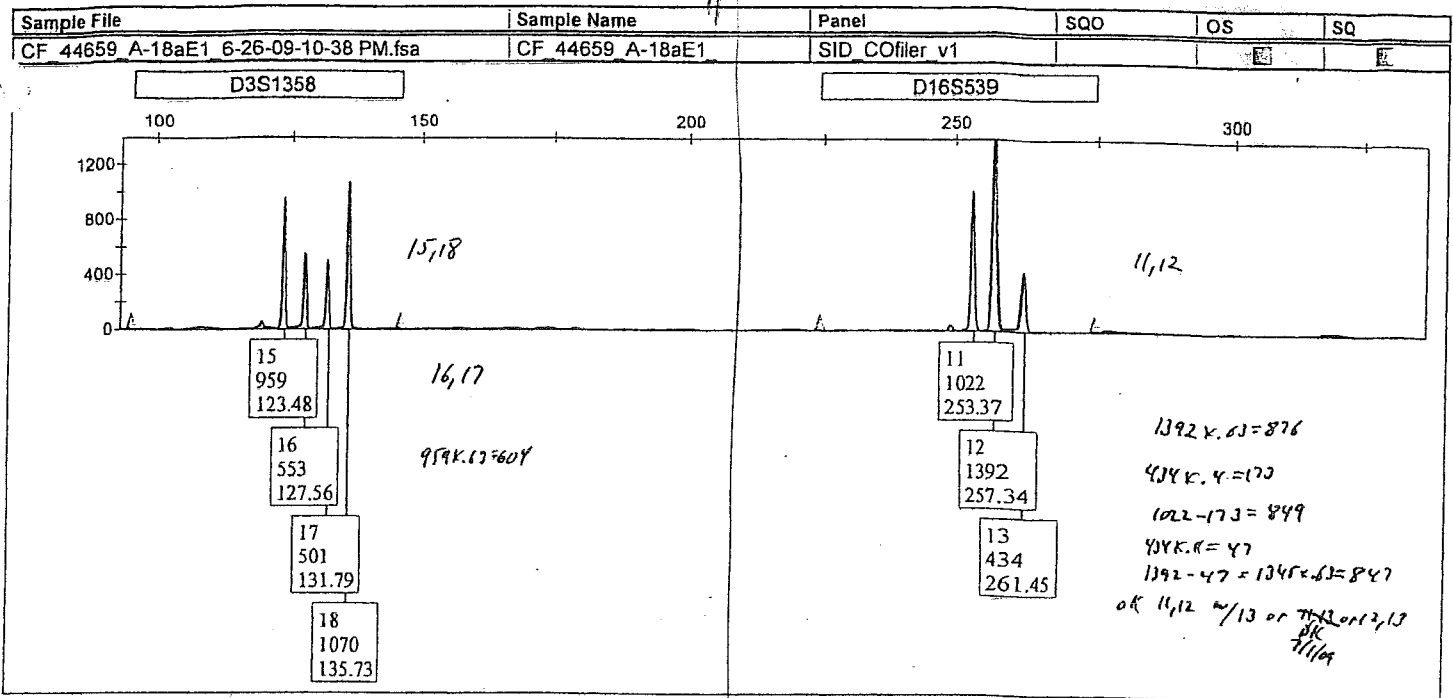

Blue = male from EL of A-189

DATE CONSISTENT WITH COMPUTER DATE

WHO DOES THE MATHEMATIC CALCULATIONS WHO TESTED?

Sample File	Sample Name	Panel	SQ0	OS	SQ
CF 44659 A-18aE1 6-26-09-10-38 PM.fsa	CF 44659 A-18aE1	SID COfiler v1			

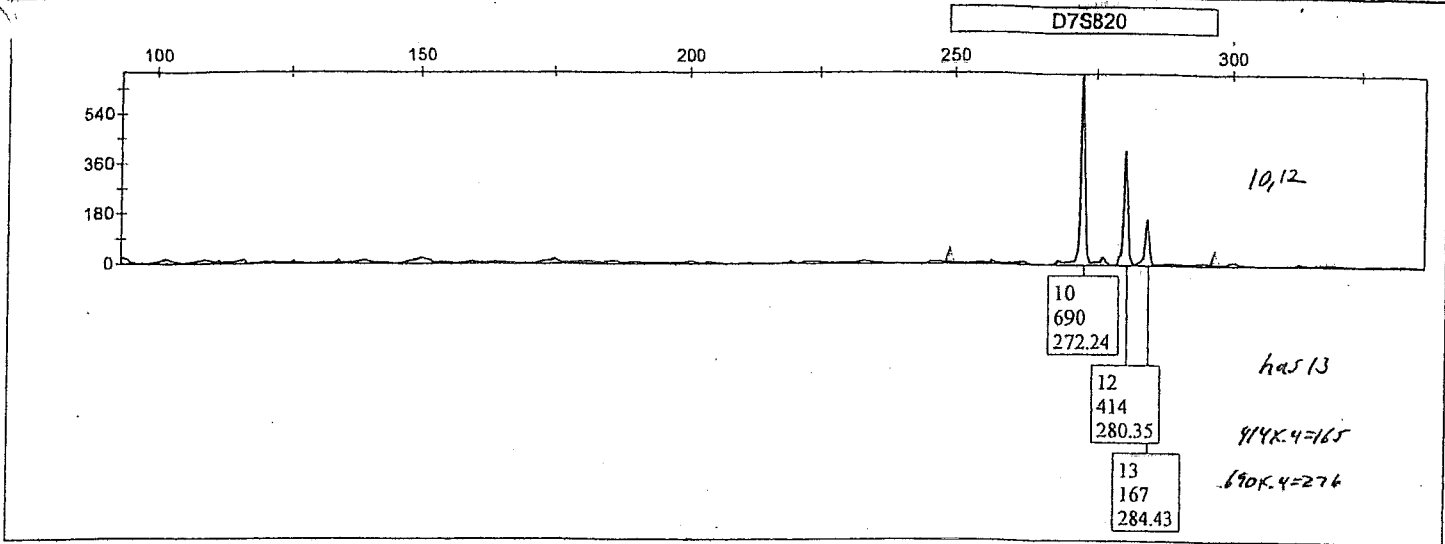

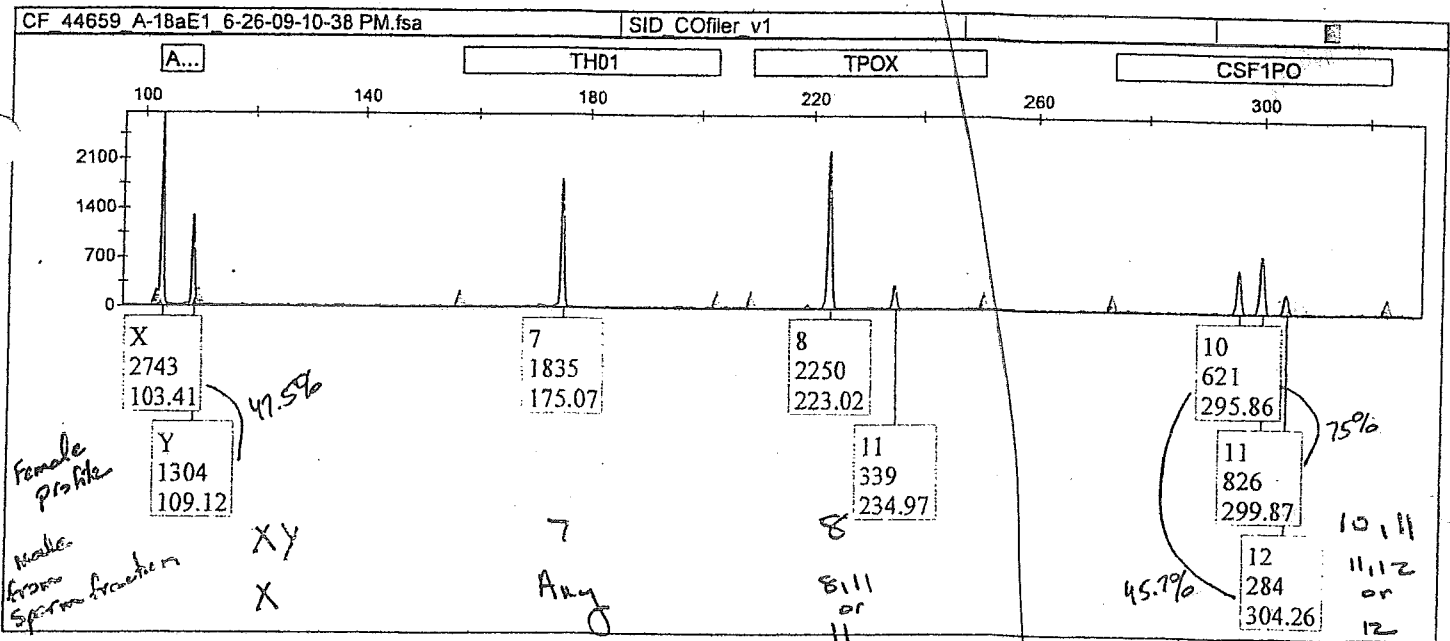
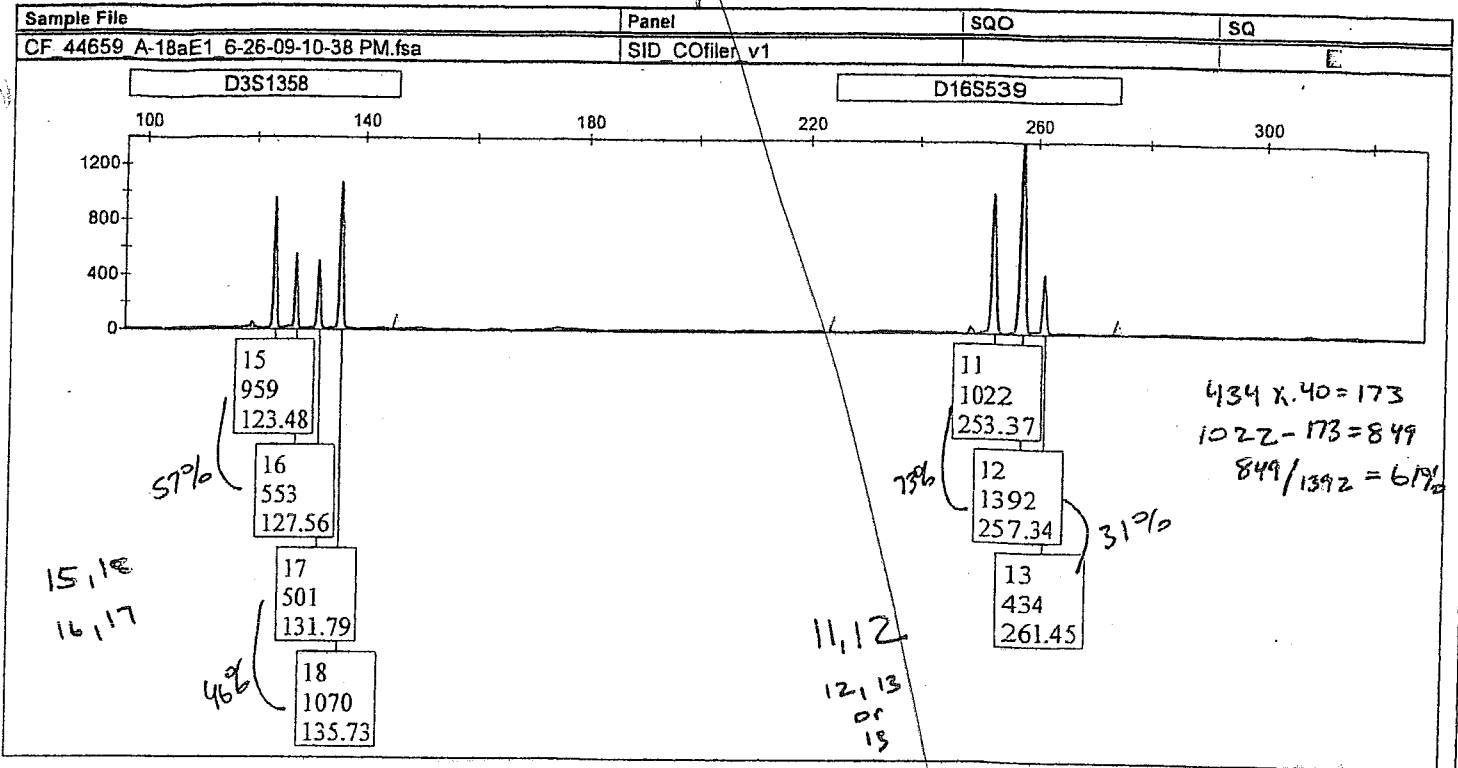

WHO IS THE DOING THE CALCULATIONS DID THEY TESTIFY? WHAT IS THEIR TRAINING

THIS DATE IS NOT CONSISTANT WITH COMPUTER GENERATED DATE

26/1/2001

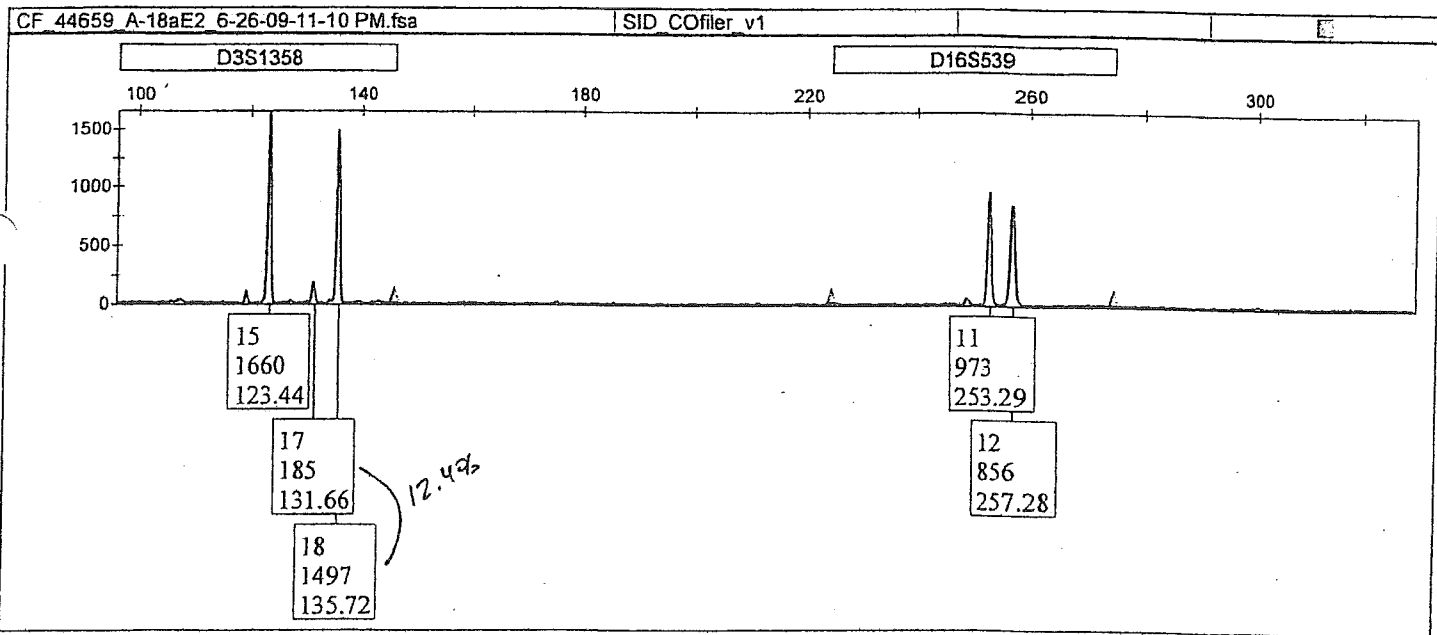
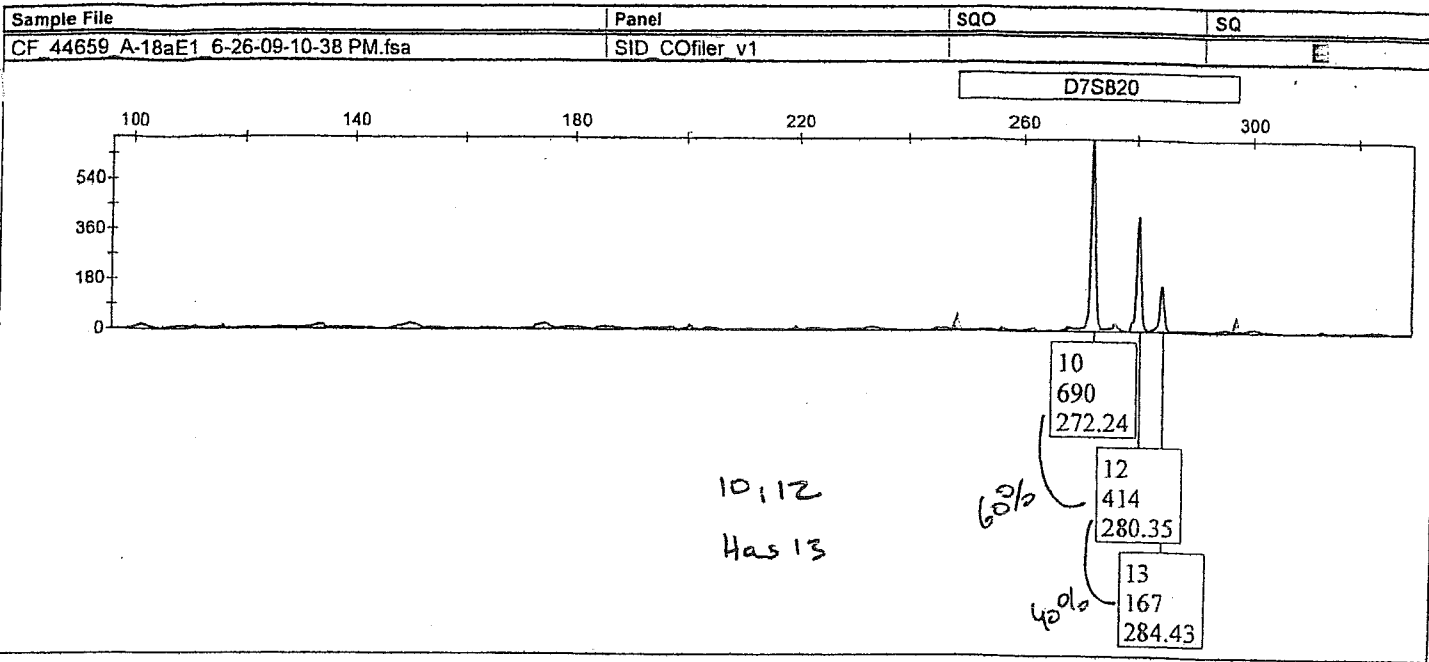

DK  
1/21/09

*gma*

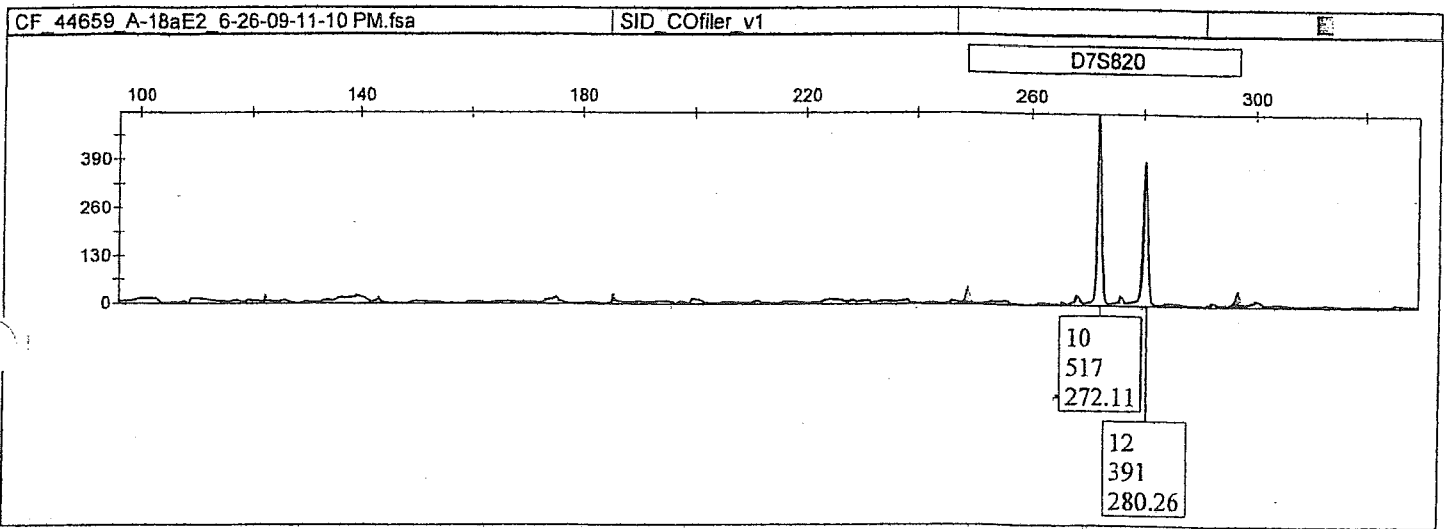
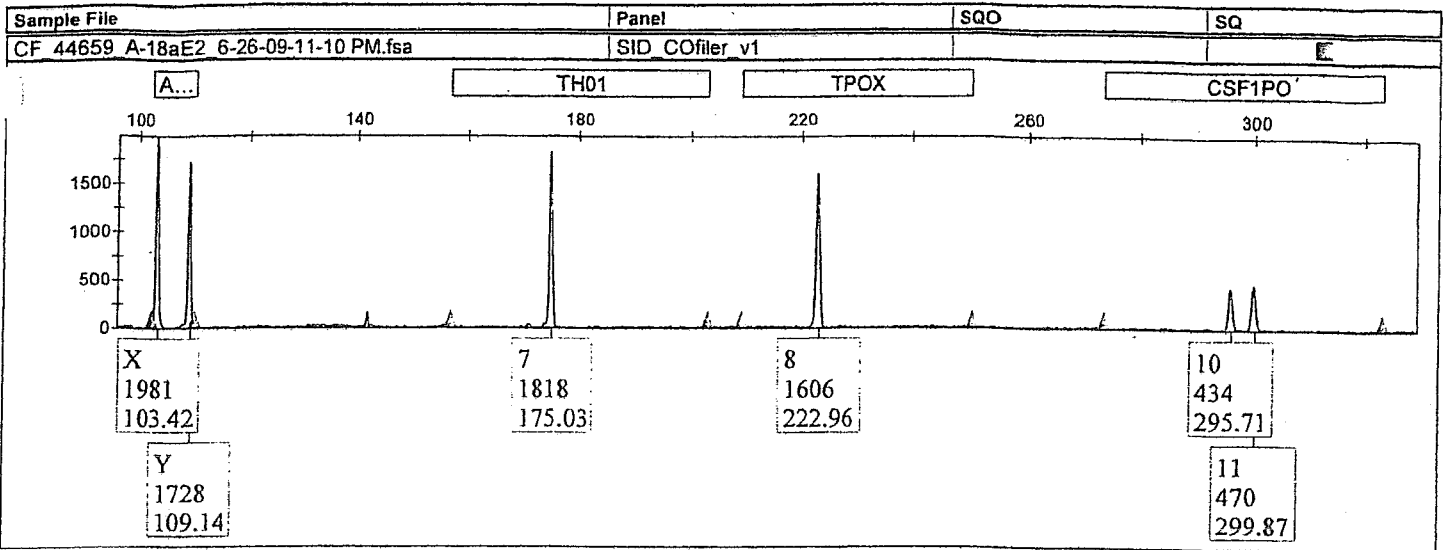

DIC  
2/2/09

*[Handwritten signature]*

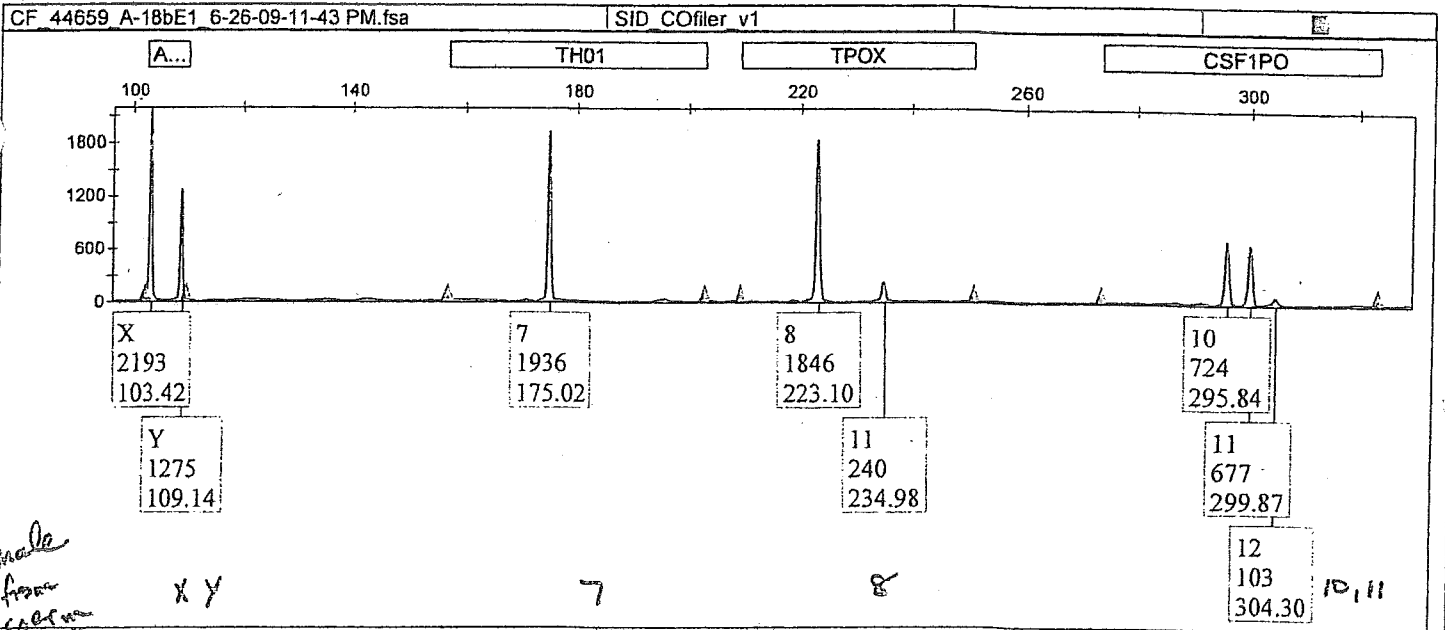
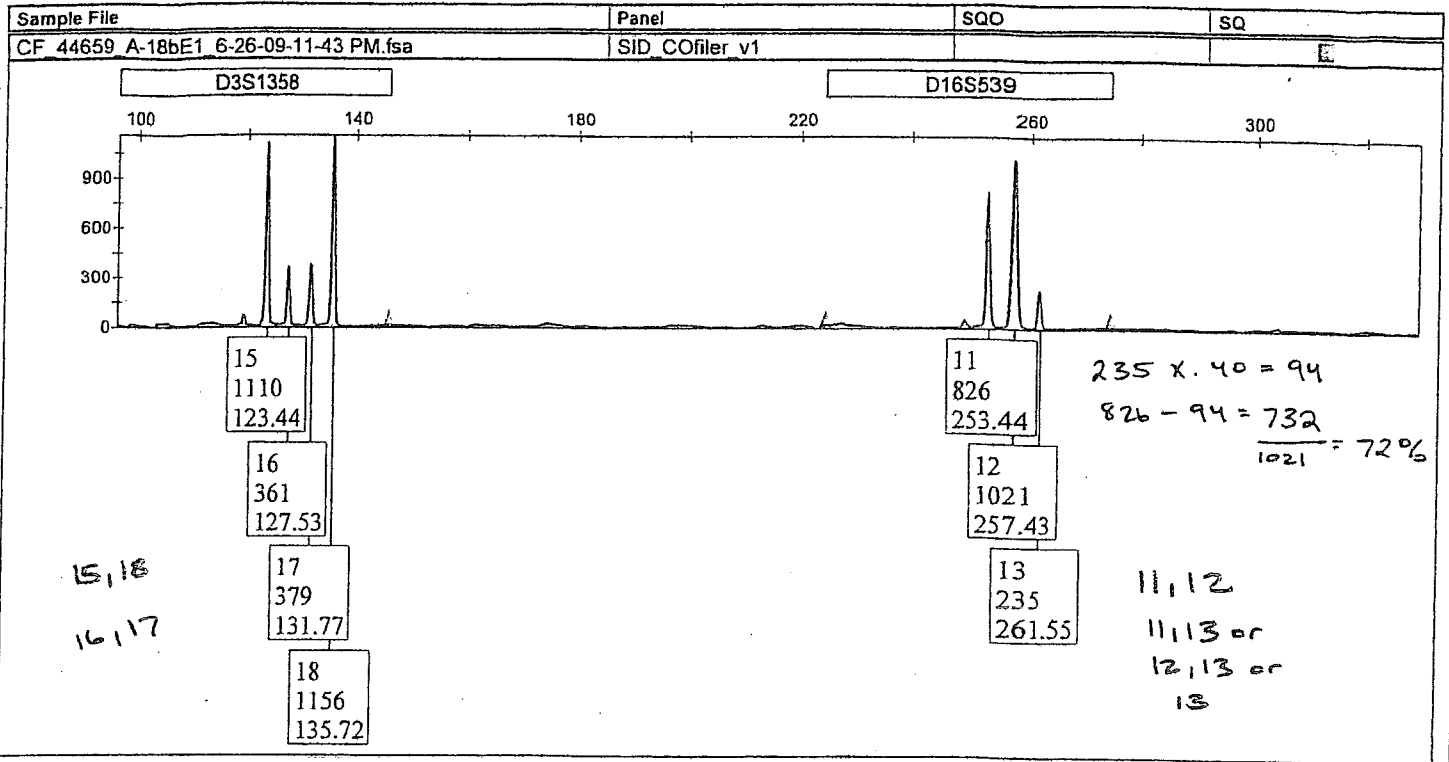

*SMA*

Sample File	Panel	SQC	SQ
CF 44659 A-18bE1 6-26-09-11-43 PM.fsa	SID_COfiler v1		

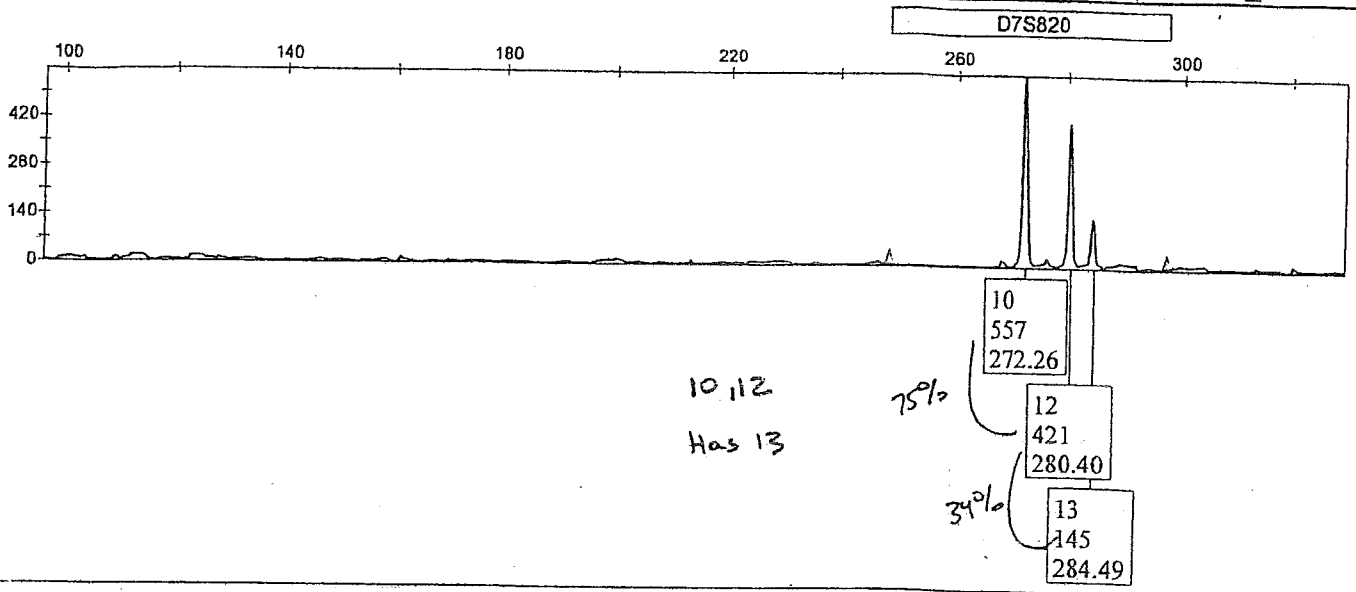

CF 44659 A-18bE2 6-27-09-12-16 AM.fsa	SID_COfiler v1		
---------------------------------------	----------------	--	--

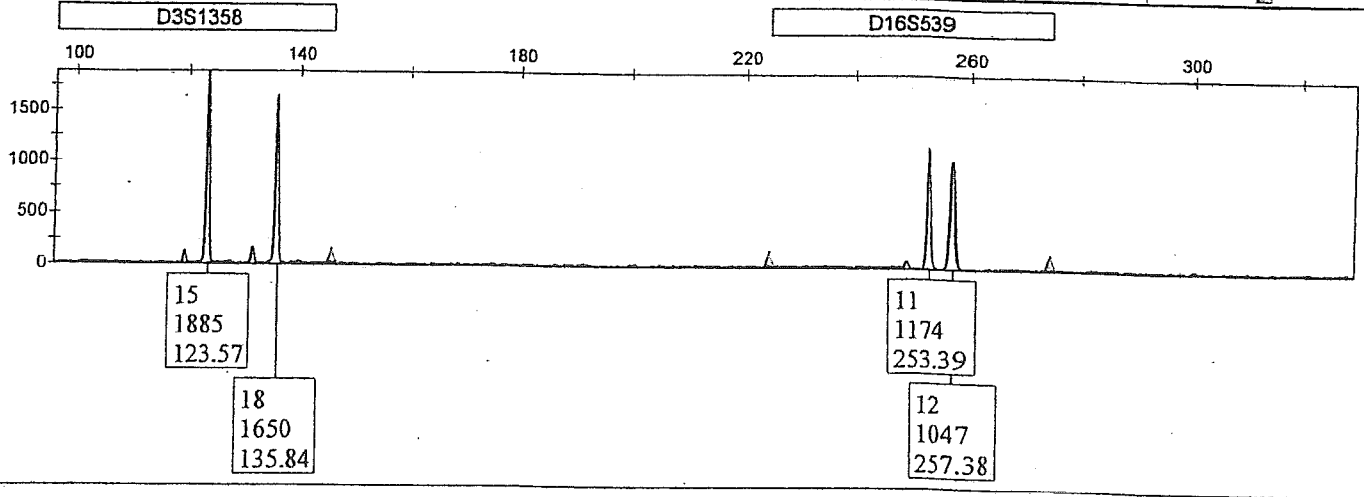

CF 44659 A-18bE2 6-27-09-12-16 AM.fsa	SID_COfiler v1		
---------------------------------------	----------------	--	--

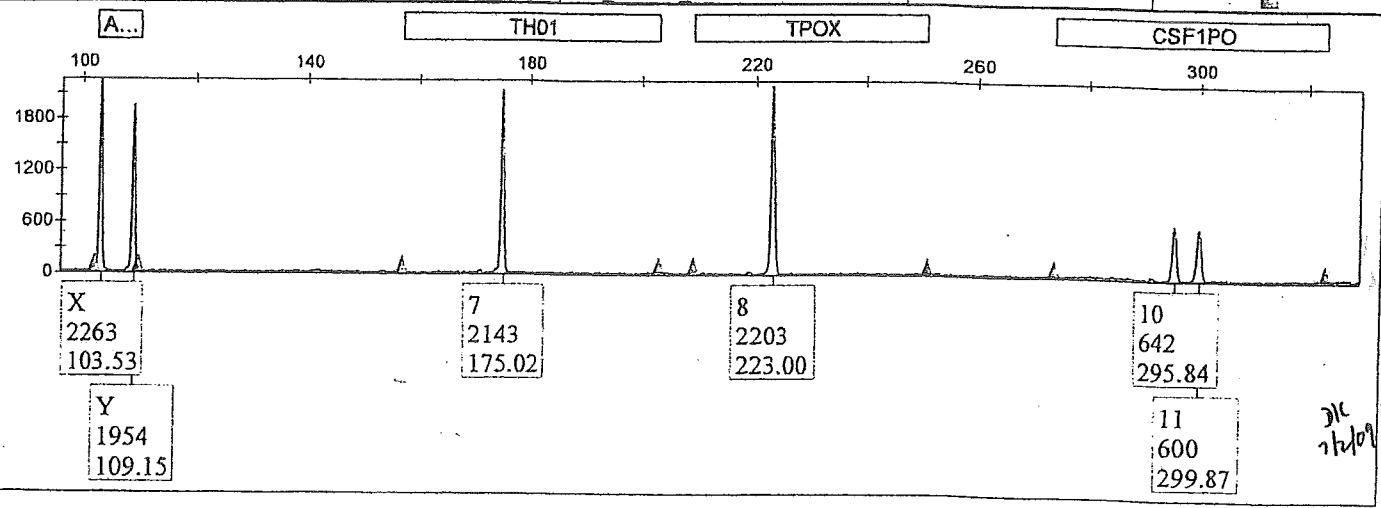



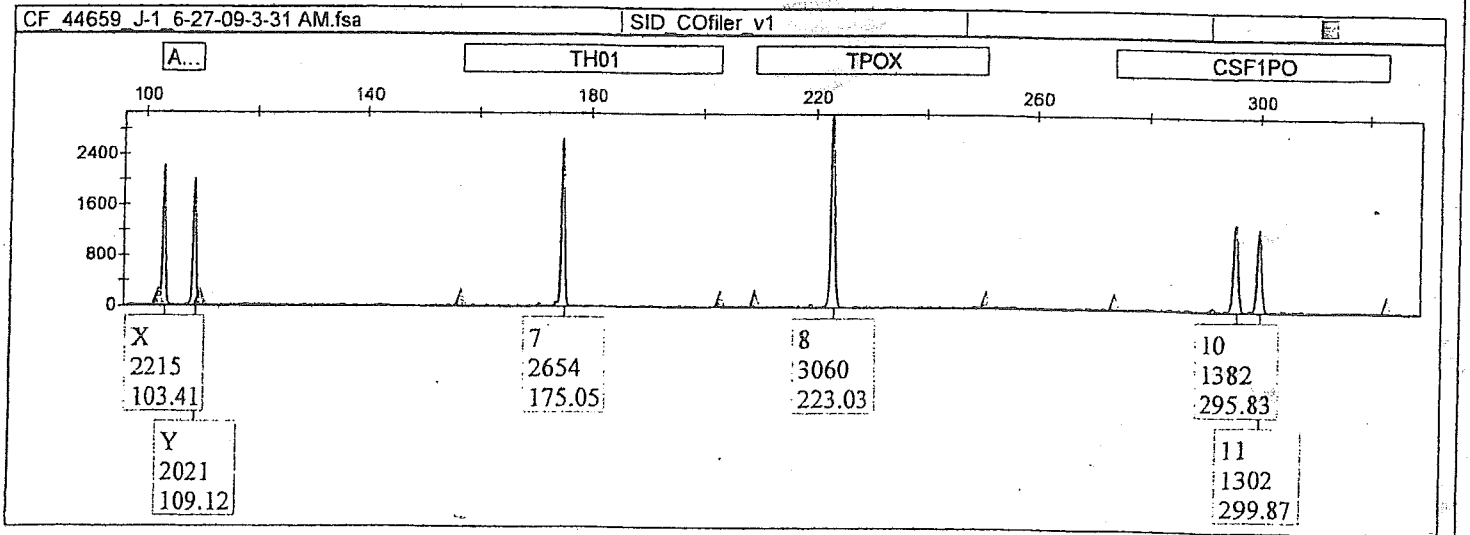
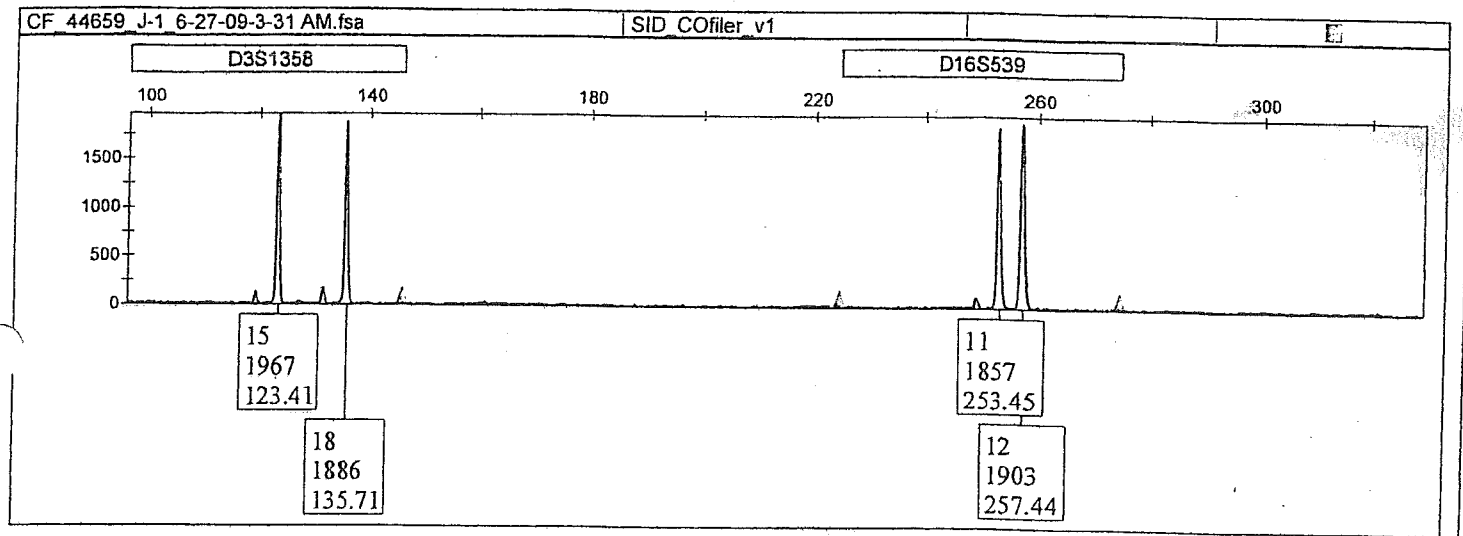
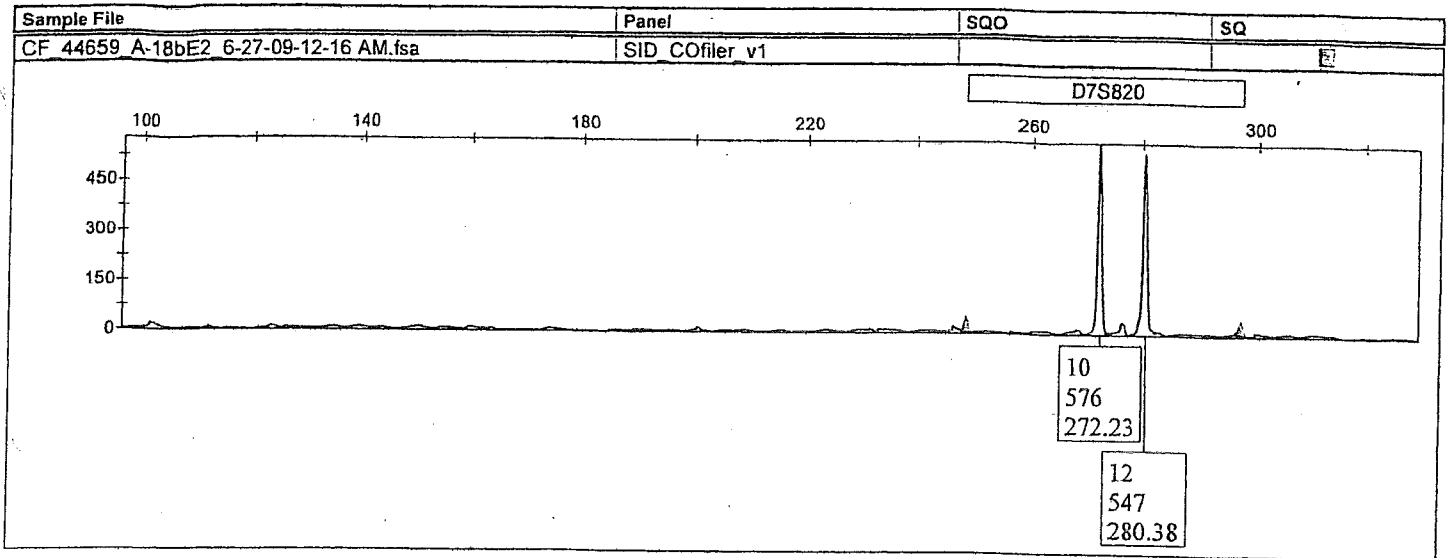

DK  
7/2/09

*gma*

Sample File	Panel	SQ0	SQ
CF 44659 J-1 6-27-09-3-31 AM.fsa	SID COfiler v1		

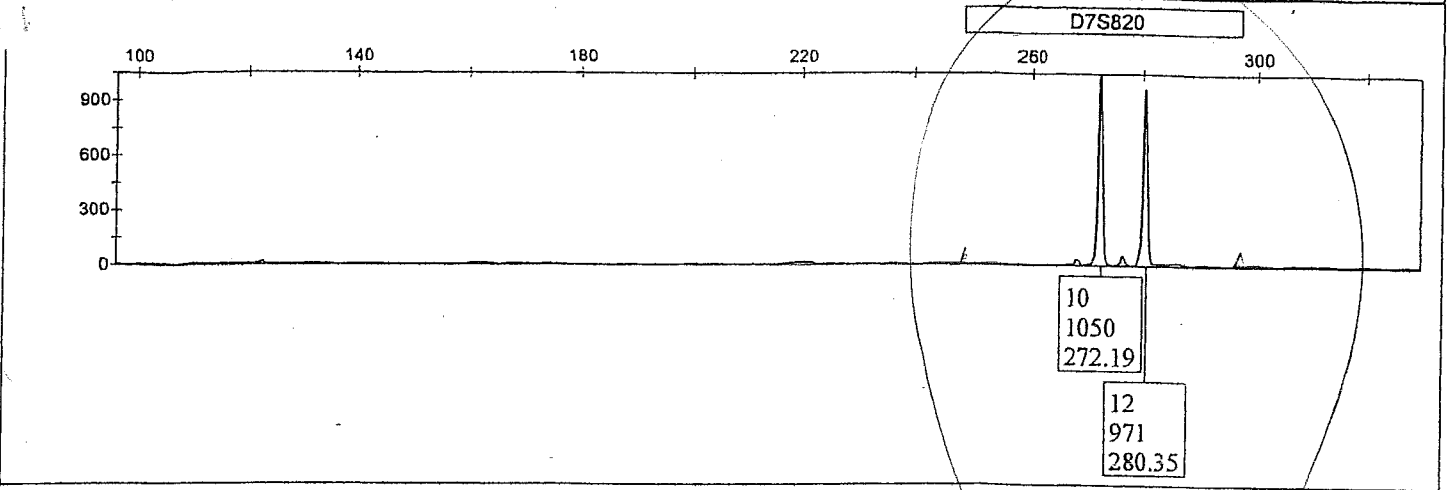

COMPARE TO 60F6  
on 6/30/09  
DIFFERENT

DK  
7/2/09

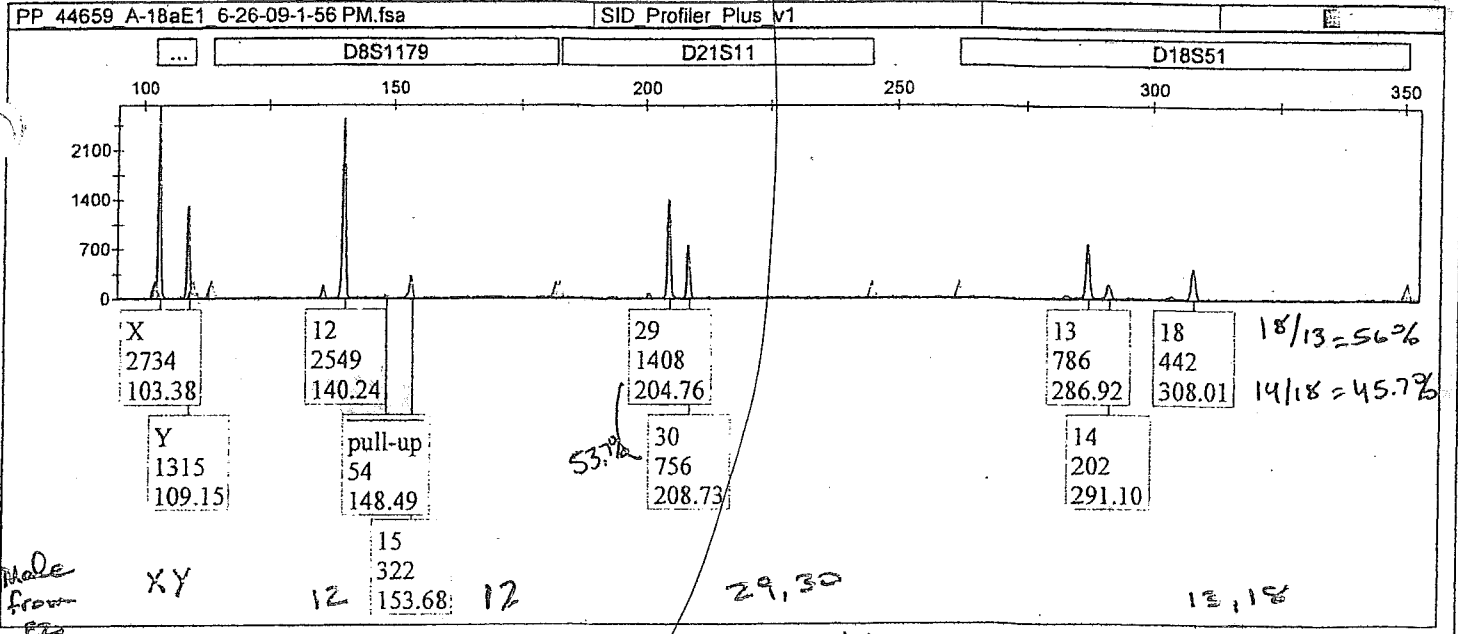
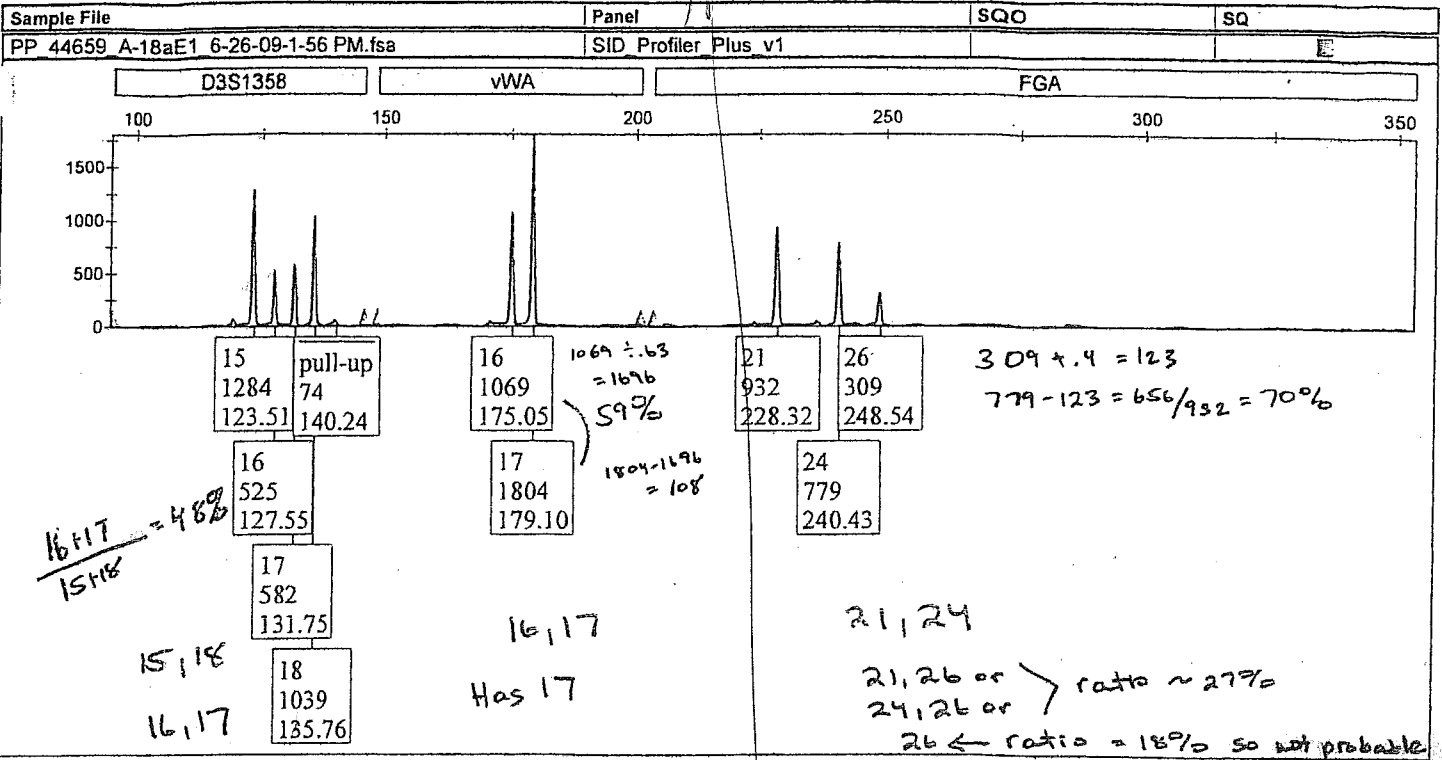

DATE INCONSISTANT WITH COMPUTER DATE  
 06/30/2009  
 Printed by: gmid

SECOND REPORTS DIFFERENT DAY DID SMA TEST IP/AT TRIAL  
 DK 7/6/09

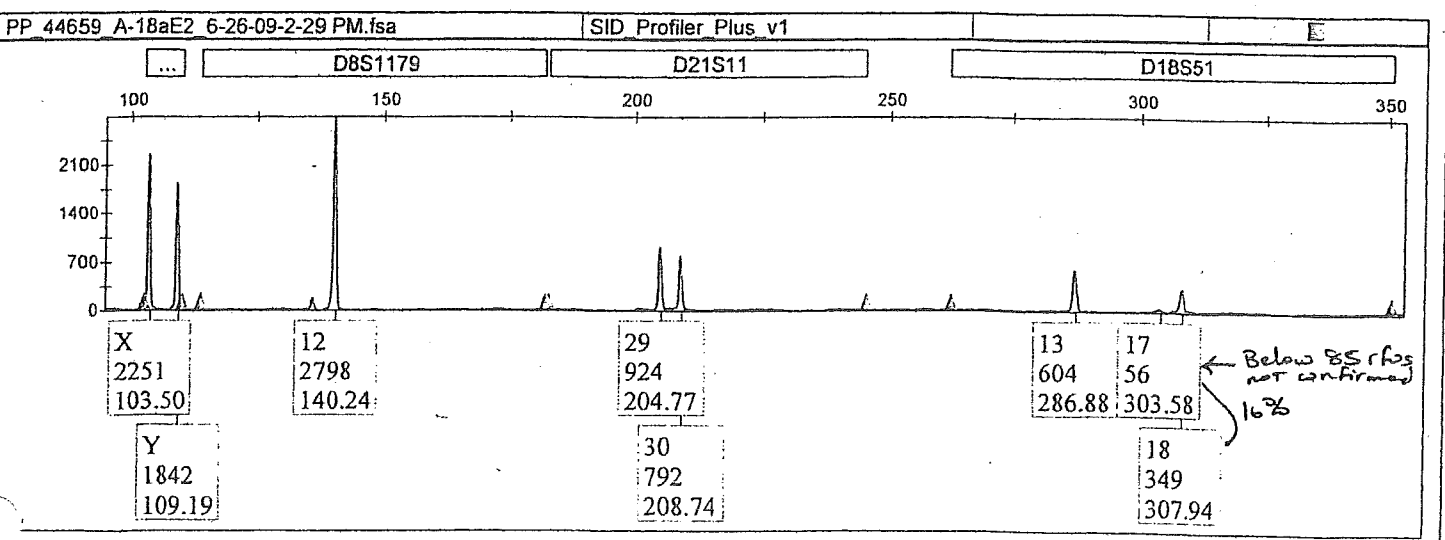
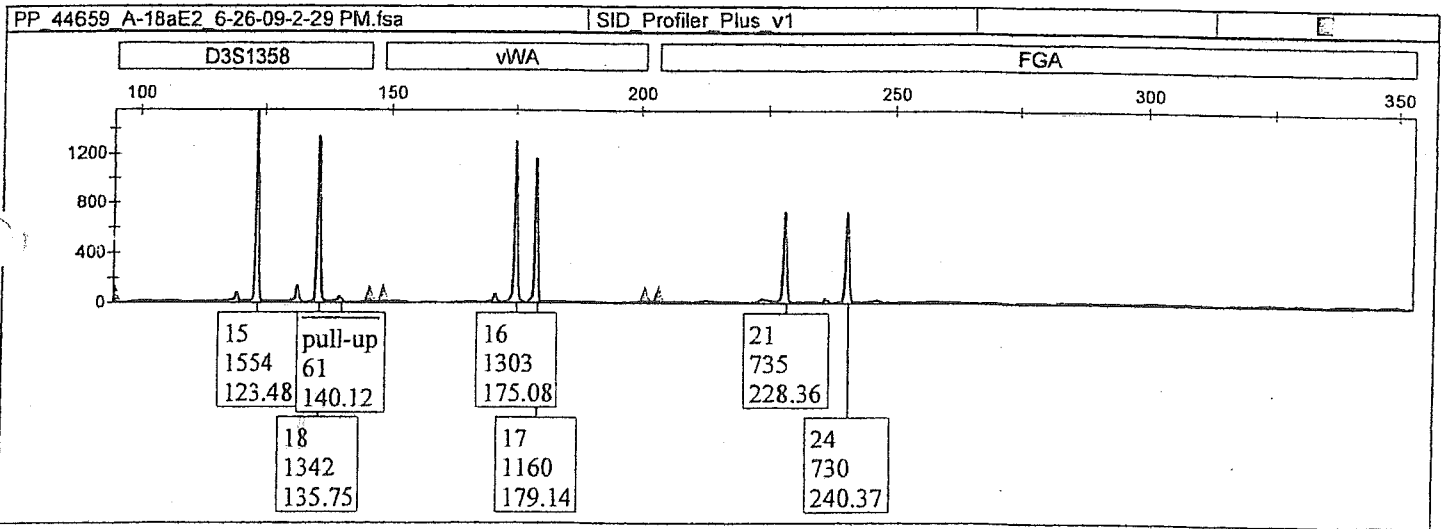
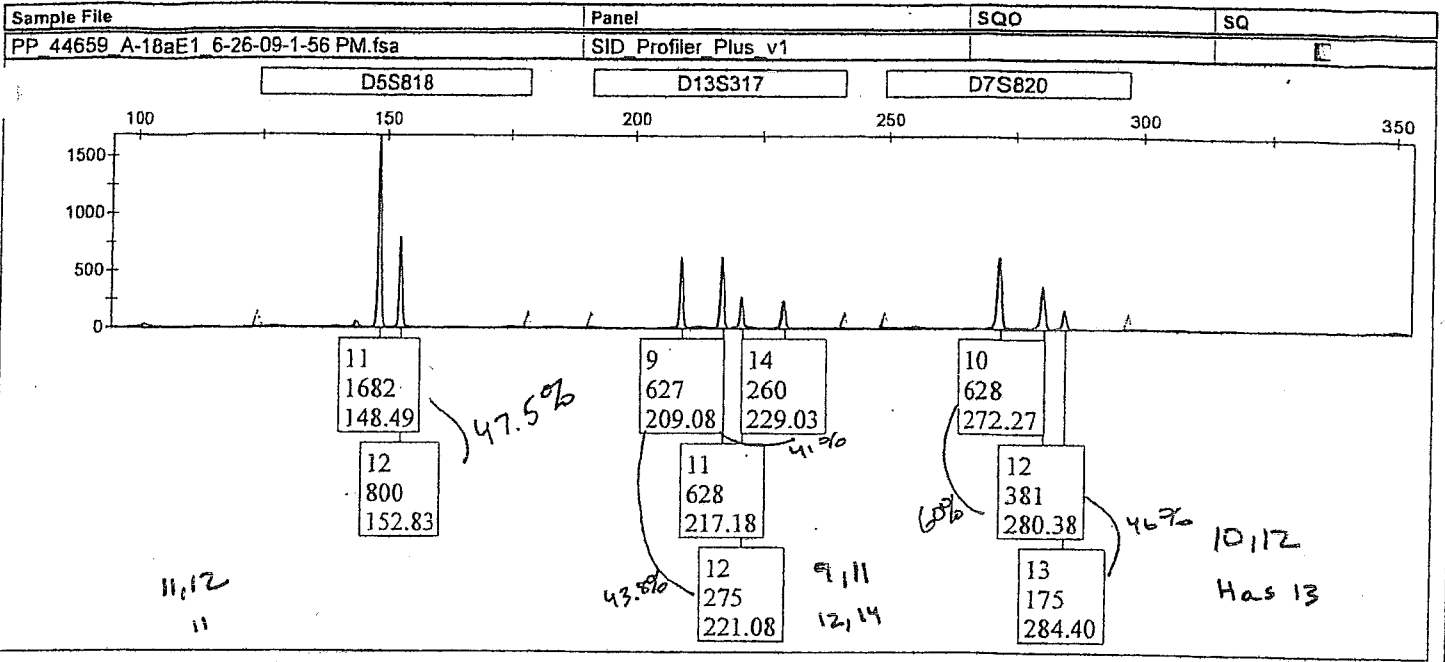

*fma*

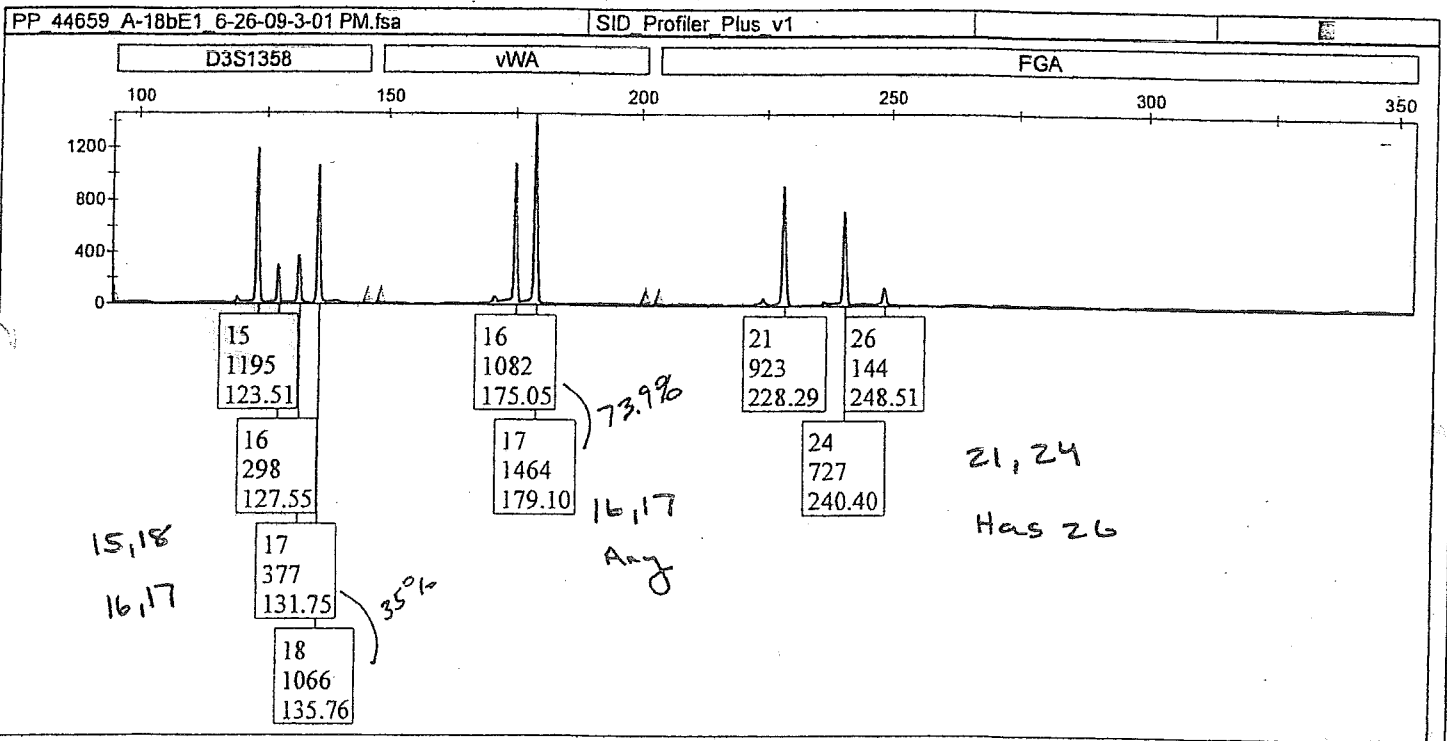
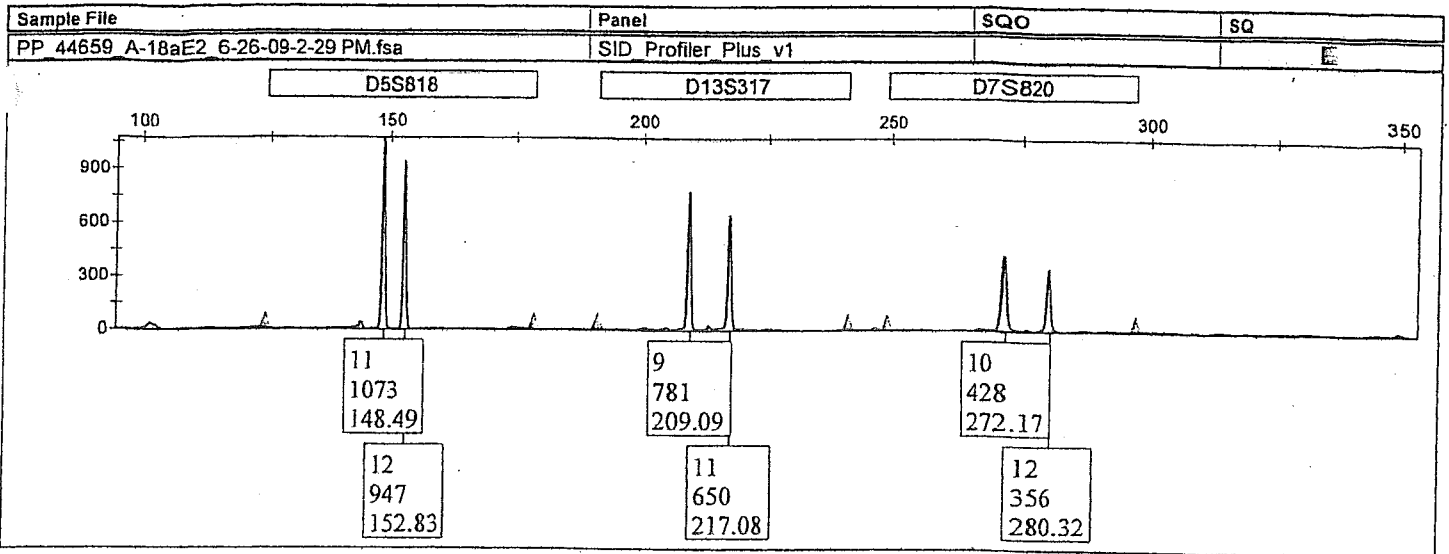

*[Handwritten signature]*

pk  
7/1/09

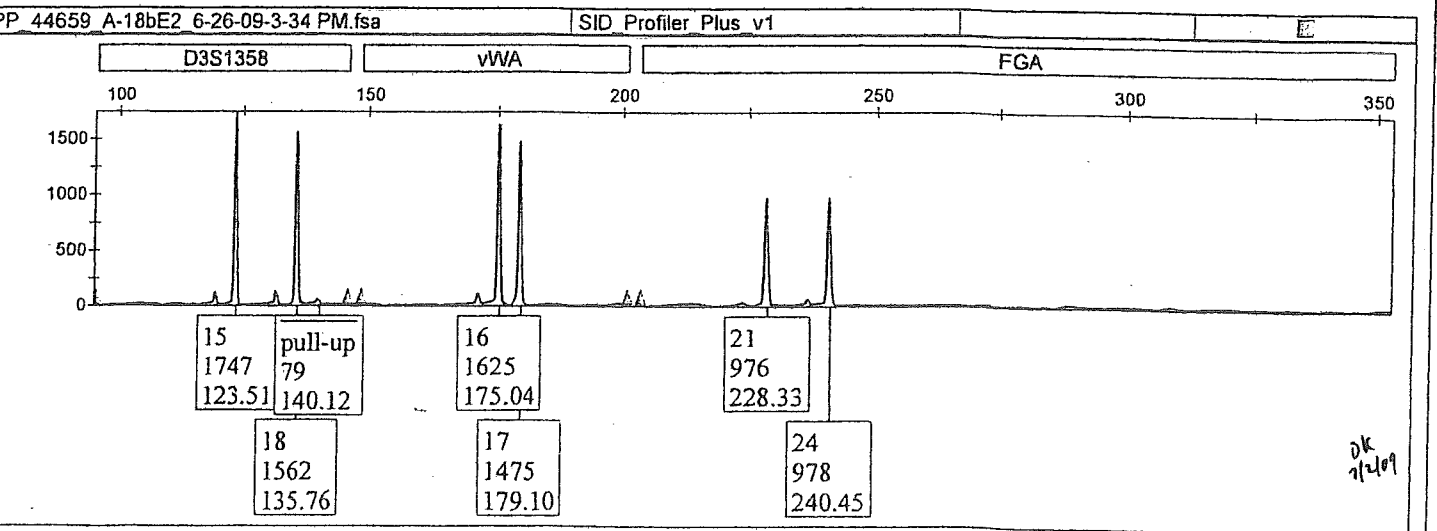
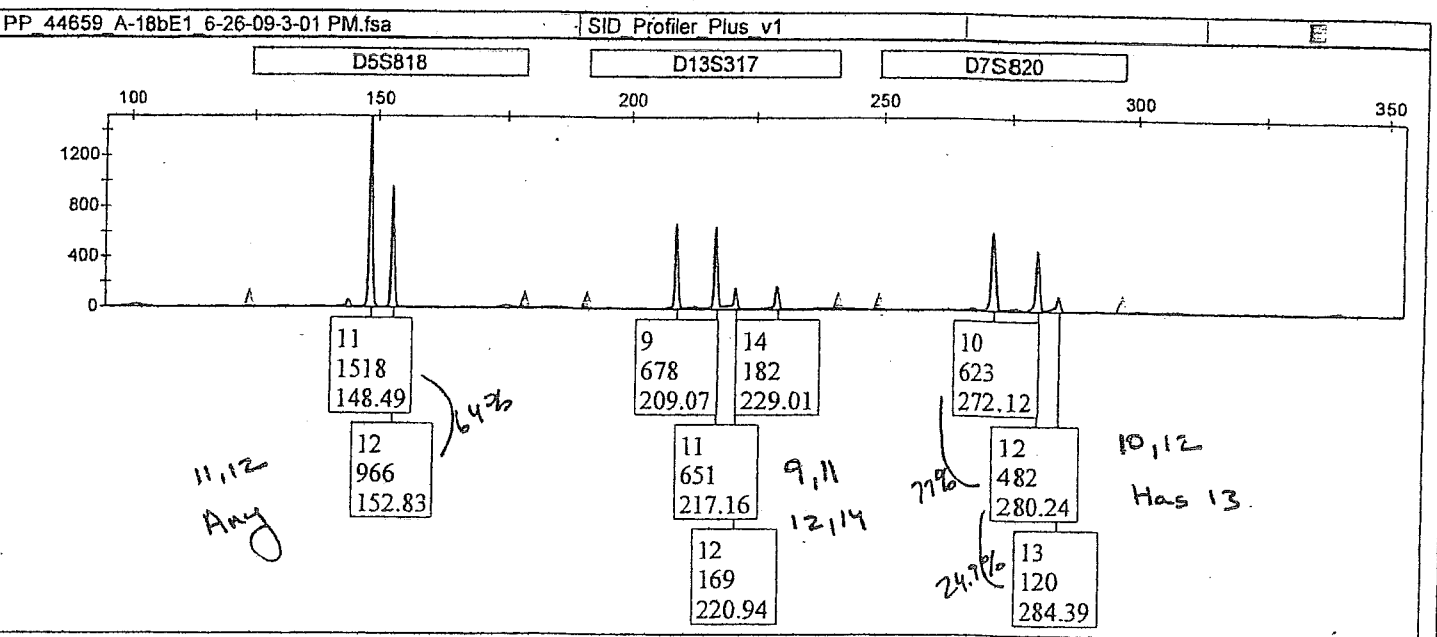
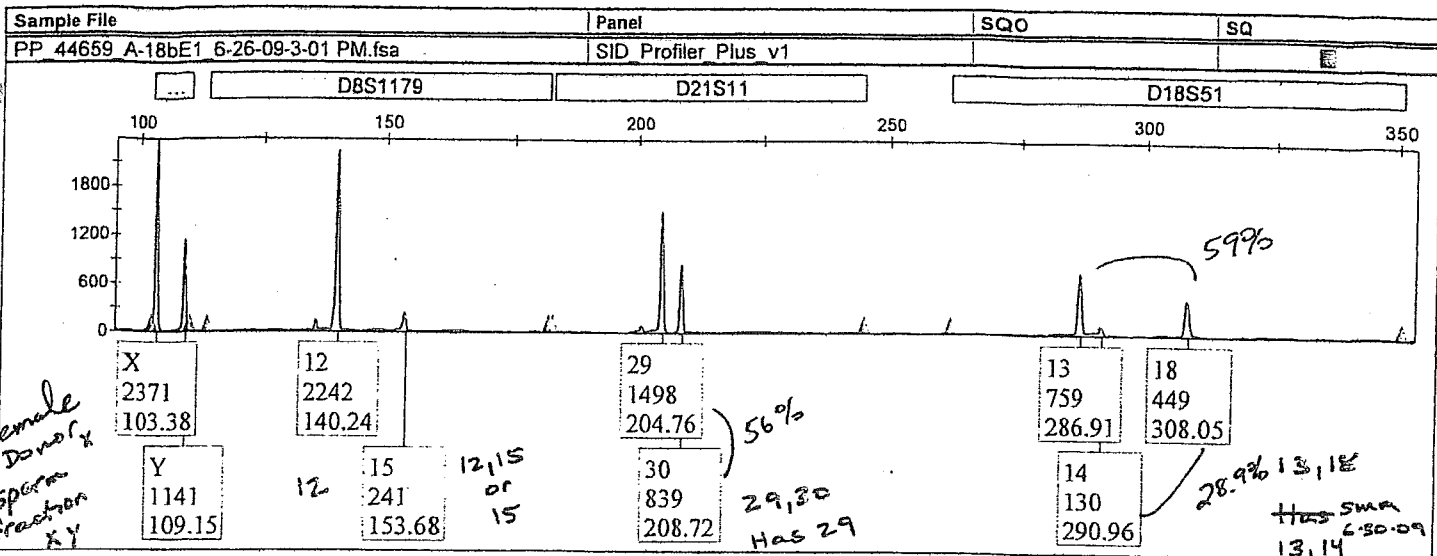

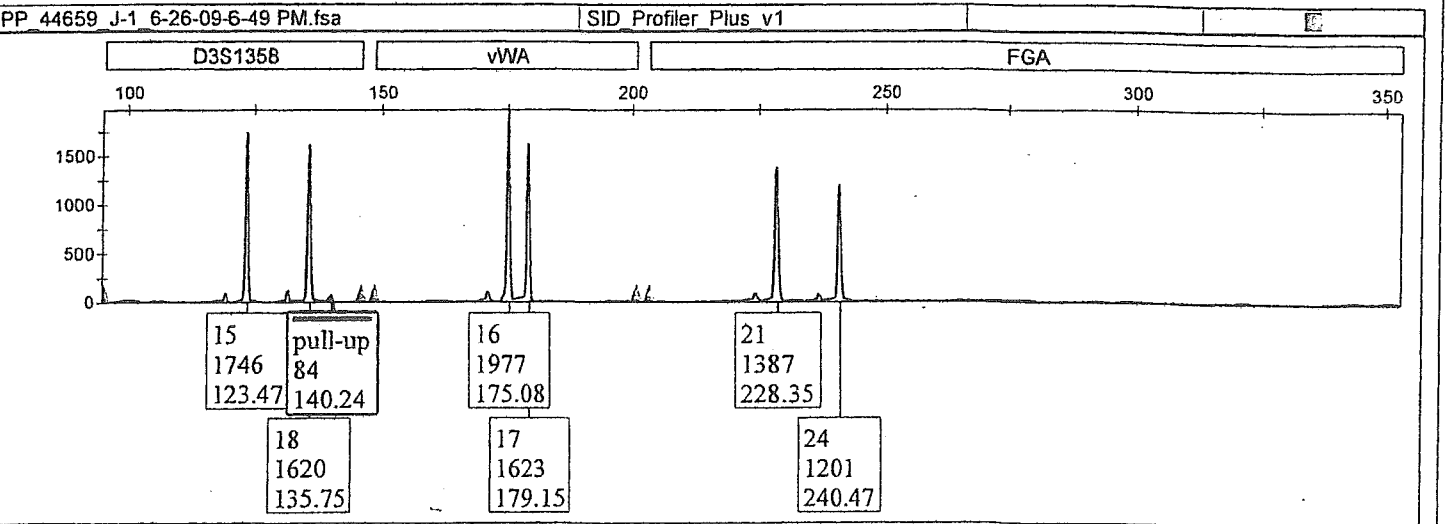
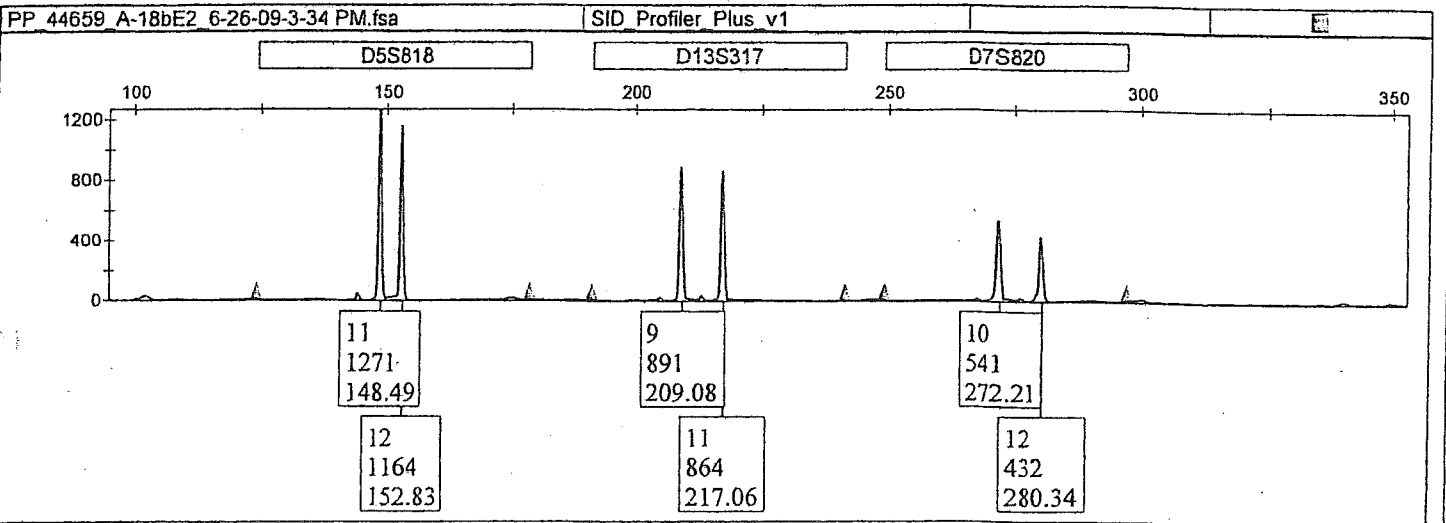
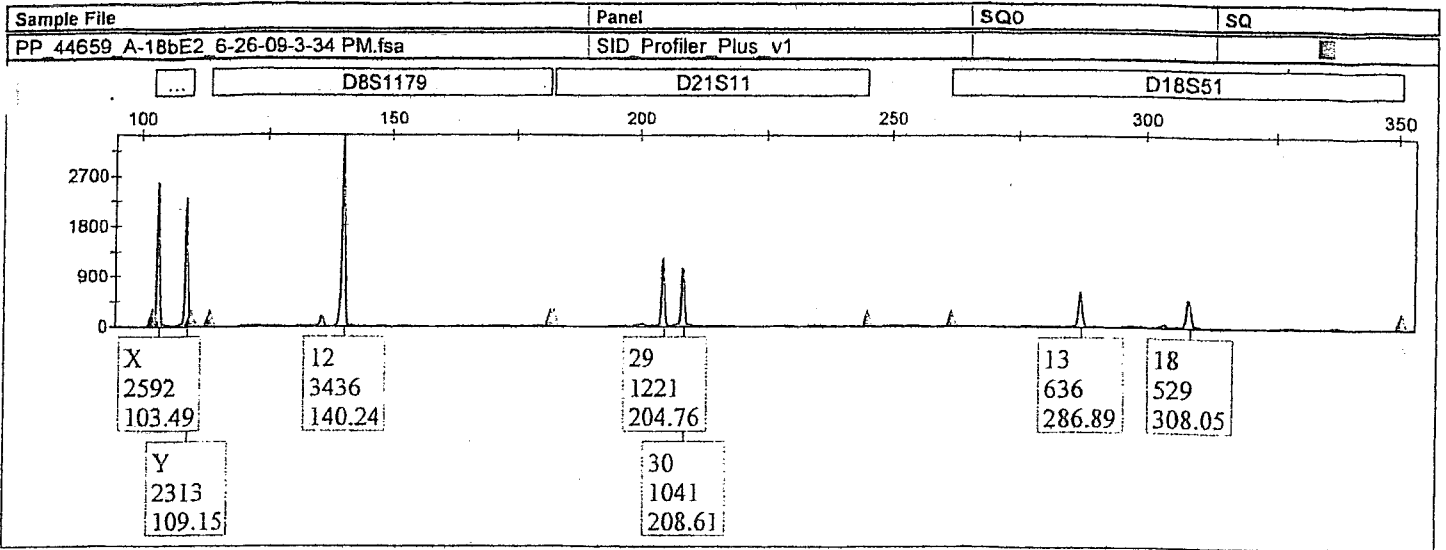

pk  
7/2/09

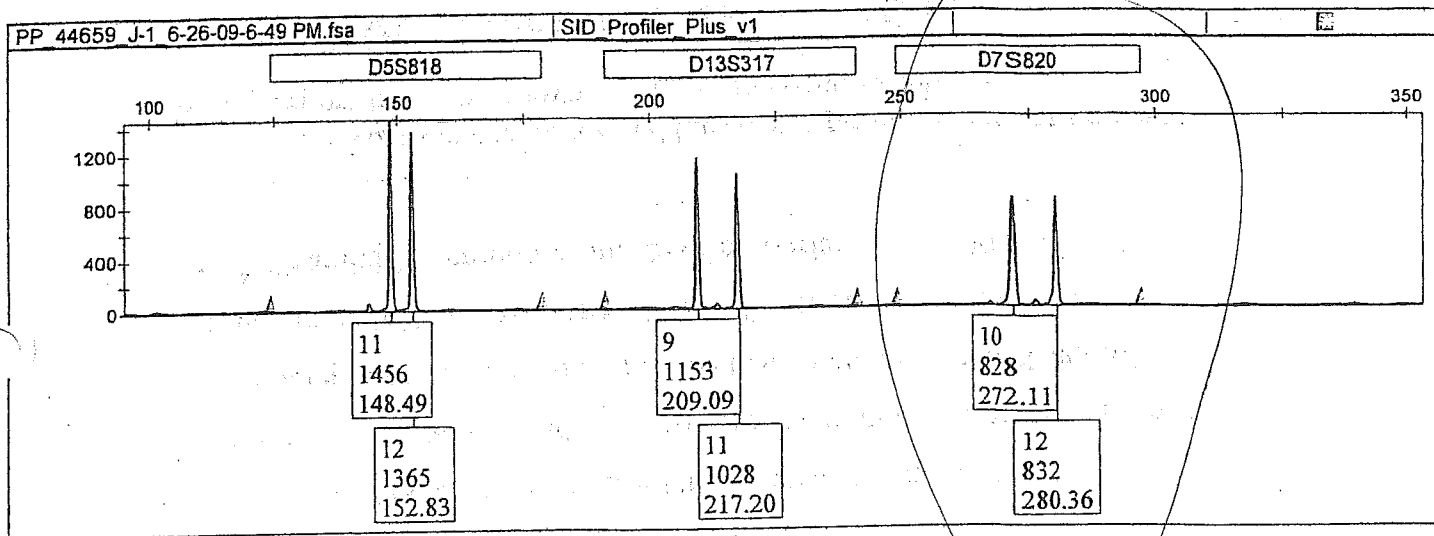
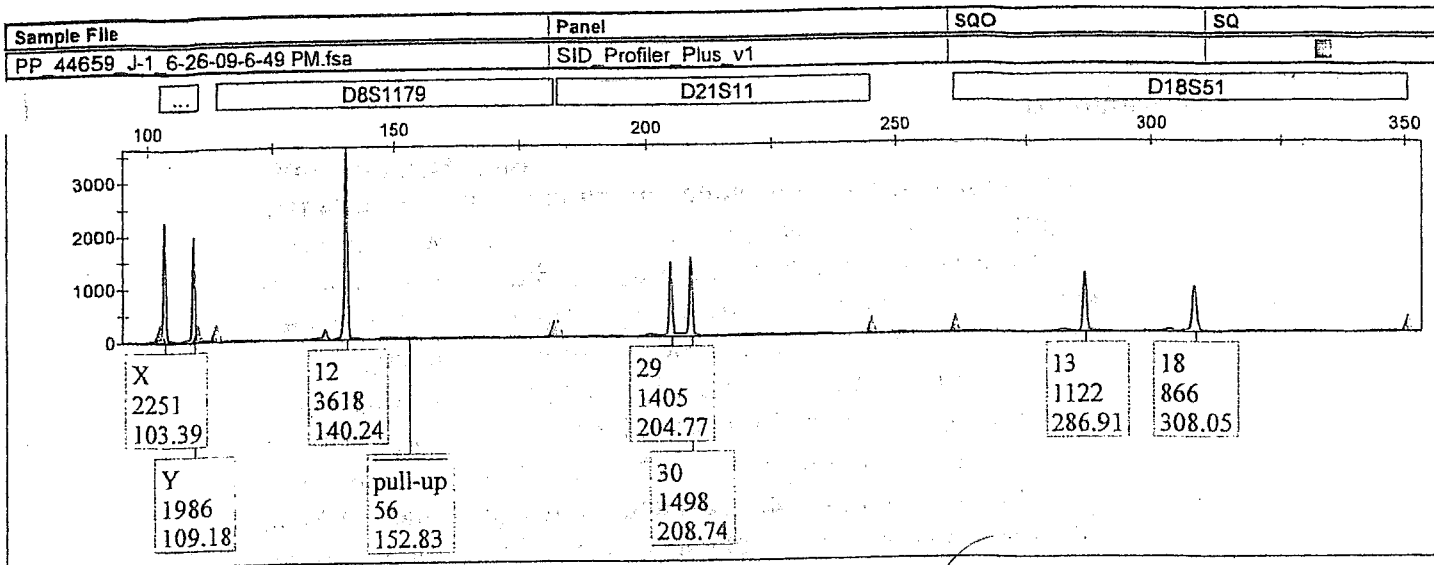

COMPARE TO  
 7 of 7 DIFFERENT  
 6-30-09  
 3 of 7 DIFFERENT  
 6-30-09  
 6 of 7 DIFFERENT  
 6-30-09  
 5 of 7 DIFFERENT  
 6-30-09

JK  
 7/4/09

*grmid*



SHERIFF'S DEPARTMENT  
 COUNTY OF SAN BERNARDINO, CALIFORNIA  
 CA03600

EVIDENCE/PROPERTY REPORT

CASE NO. 1331036-07  
 REPORTING AREA  
 SB5D Homicide

CODE SECTION 187 P.C.	RECOVERING DIV/STATION SB5D Homicide	SUSPECT NAME UNKNOWN	RECOVERED BY AND EMPLOYEE NO. Don Jones 50698
<input checked="" type="checkbox"/> EVIDENCE	<input type="checkbox"/> FOUND PROPERTY	<input type="checkbox"/> SAFEKEEPING	<input type="checkbox"/> SEARCH WARRANT
<input type="checkbox"/> RECOVERED PROPERTY	<input type="checkbox"/> REPORTED STOLEN		

OWNER OF PROPERTY	ADDRESS
-------------------	---------

CASE AGENT AND EMPLOYEE NO. Lt P. Ortiz 00321	PROPERTY RECOVERED BY AND EMPLOYEE NO. Don Jones 50698
--	---

ITEM NO.	SERIAL NO.	DESCRIPTION	VALUE	BAR CODE LABEL
1		6x9 million @ DNA extraction materials		9842018029  SAN BERNARDINO COUNTY SHERIFF

THIS WAS SUBMITTED 3 YEARS AFTER THE CRIME WAS COMMITTED  
 3 YEARS AFTER THE FACT

REPORTING DEPUTY AND EMPLOYEE NO. Don Jones 50698	DATE 2-13-98	REVIEWED BY	PROPERTY OFFICER AND EMPLOYEE NO. Don Jones H3266	DATE 2-13-98
--	-----------------	-------------	--	-----------------

DON JONES  
 771

# EXHIBIT COVER PAGE

P2

EXHIBIT

DESCRIPTION OF THIS EXHIBIT:

NUMBER OF PAGES TO THIS EXHIBIT: 4 PAGES

JURISDICTION: (CHECK ONLY ONE)

MUNICIPAL COURT

SUPERIOR COURT

APPELLATE COURT

STATE SUPREME COURT

UNITED STATES DISTRICT COURT

STATE CIRCUIT COURT

UNITED STATES SUPREME COURT

GRAND JURY

**SHERIFF'S DEPARTMENT  
COUNTY OF SAN BERNARDINO  
CALIFORNIA  
CA 03600**

CASE NO.

Dr# 1331036-07

H# 100-85

REPORT AREA

Page 3

SECTION Pc 187		CRIME Murder	CLASSIFICATION Felony	
VICTIM'S NAME - LAST NAME	FIRST NAME	MIDDLE NAME	(FIRM NAME IF BUSINESS)	
ADDRESS	RESIDENCE			PHONE

- Item A18 - Debris from felt pad
- Item A17 - Debris from gag
- Item A18 - Debris from other items
- Item A14 - Debris from pillow underneath head
- Item A13 - Debris from A13
- Item A2 - Debris from A-Z

At the completion of viewing the evidence I repackaged the evidence and turned it back into the custody of the Property Division.

REPORTING OFFICER Greg Myler	DATE 01/15/2009	REVIEWED BY	TYPED BY	ROUTED BY	DATE
OTHER ACTION: <input checked="" type="checkbox"/> YES <input type="checkbox"/> NO	COPIES TO:	REMARKS			
<input type="checkbox"/> Detective	<input type="checkbox"/> Other	<input type="checkbox"/> SD/PD			
<input type="checkbox"/> Dist. Atty.	<input type="checkbox"/> CII	<input type="checkbox"/> Other			
<input type="checkbox"/> Patrol					

143  
411

100  
175

PHOTO # LOCATION

- 34-----Showing a cigarette butt located on the front porch of the victims residence.
- 35-----Close up of that cigarette butt.
- 36-----Is an ashtray located between two wooden chairs with cigarette butts located in them.
- 37-----Close up of that same ashtray.
- 38-----Rear view of the victims residence.
- 39-----View of a small house located behind the victims resi
- 40-----Picture of a jeep located along side the victims resi
- 41-----Is a picture of the victim located in the bedroom lay
- 42-----Photograph of the victim.
- 43-----Photograph of the victim.
- 44-----Photograph of the victim and a golf club located alor
- 45-----Photograph of clothing, golf club.
- 46-----Photograph of a ring on a night stand beside the vic
- 47-----A close up of that ring.
- 48-----The victims underwear lying beside the bed.
- 49-----A photograph of the victim.
- 50-----A close up of the victim.
- 51-----A close up of the victim from the other side.
- 52-----Is a photograph of a watchband pin.
- 53-----A close up of that watchband pin.
- 54-----A photograph of the victim and the headboard.
- 55-----Overall photograph of the victim and the waterbed.
- 56-----A close up of the wire around the victims neck.
- 57-----A overall photograph of the victim showing levity.
- 57-----Photograph of the location where the victim was lying.
- 59-----A photograph of a possible blood smear located on the door as you enter the victims bedroom.
- 60-----The same photograph.
- 61-----Possible blood stain on the door frame leading from the study to the hallway into the victims bedroom.
- 62-----The same as #61.
- 63-----Photograph of pictures located in the victims study.
- 64-----The same as #63.
- 65-----Overall of the autopsy.
- 66-----The overall of the post itself.
- 67-----Overall of the post.
- 68-----Close up of victims head.
- 69-----Overall of the victims body from the head portion.
- 70-----The same as #69.
- 71-----A close up showing the wire around the victims neck.
- 72-----Same as #71.
- 73-----Same as #72.
- 74-----A photograph of the victims vaginal area showing blood.
- 75-----Overall of the victims body.
- 76-----Close up of the wire wrapped around the victims neck.
- 77-----Oops.
- 78-----Wire wrapped around the victims neck.
- 79-----Wire after its removed from the victims neck.

*THIS IS A RAY  
HAND*

*PA STAFFED A  
SERVING KNOCKED TO THE  
THE GROUND  
NO RING  
PROB HAVE  
LEFT  
BEARD WAS RECORDED  
WAS A GOLD WATCH  
FOR DINA PIN WAS NOT  
LEVITY IS ON  
RIGHT SIDE SHOWING  
BODY BUT PHOTOS SHOW  
BODY BACK ON HER  
BACK LEVITY  
WOULD BE ON BACK  
NOT SIDE IF SHE  
DIED ON HER  
BACK.*

*THE BODY WAS  
MOVED //*

141

101  
176

71

SHERIFF'S DEPARTMENT  
COUNTY OF SAN BERNARDINO  
CALIFORNIA  
CA 03600

Page 2

CASE NO.  
Dr# 1331036-07  
H# 100-85  
REPORT AREA

SECTION Pc 187	CRIME Murder	CLASSIFICATION Felony (FIRM NAME IF BUSINESS)
VICTIM'S NAME - LAST NAME	FIRST NAME	MIDDLE NAME
ADDRESS	RESIDENCE	PHONE

TAG #B67999: (From east corner of bed beneath comforter)

Microscopic Slide Box

- Item B4F - Standard head hair
- Item B4D - Standard pubic hair
- Item A18 - Possible pubic hair from felt pad
- Item A17 - Hair from gag
- Item A16 - 1, 2, 3 hair
- Item A5 - 1-8 and 1 hair with root
- Item A4 - 7 slides with hair
- Item A1 - 8 slides, 1 with root

THESE ARE DNA'S  
THAT WERE AT  
SCENE THAT WERE  
NOT TESTED NOR  
INVESTIGATED

- Item A17 - (1) White pant used as a gag
- Item A18 - (1) Brown and tan felt desk pad
  - (1) Tan bra "Equisite" form in group 384 size 36B
  - (1) Red pair of shorts "Lady La Mode" active sports wear size 8
  - (1) Blue blazer button up "Phil Carry" size 12
  - (2) White pillow cases with colored flower designs

- Item B3 - (1) Metal coat hanger
- Item A3 - (1) Panty
- Item B2 - (1) Tissue from victim's chin
- Item B5 - Victim's dentures

DNA

Item A15 - Watch band keeper (west of victim's head beneath pillow)

Item B1 - Loose Hair(s) from victim's torso

DNA. WHAT WAS FOUND?

- Item A22 - Standard from carpet
- Item A4 - Vacuum sweepings from area east of bed
- Item A16 - Vacuum sweepings from bedding
- Item A1 - Vacuum sweepings of carpet inside doorway and hair from vacuum
- Item A5 - Vacuum sweepings south and west side of bed
- Item A-6 thru A-10 - Tape lift of victim's torso

WHAT FOUND?

REPORTING OFFICER Greg Myler	DATE 01/15/2009	REVIEWED BY	TYPED BY	ROUTED BY	DATE
OTHER ACTION:	COPIES TO:	REMARKS			
<input type="checkbox"/> Other	<input type="checkbox"/> SD/PT				
<input type="checkbox"/> Det. Inv.	<input type="checkbox"/> Other				
<input type="checkbox"/> Dist. Ally.	<input type="checkbox"/> Patrol				

C

134  
410

**SHERIFF'S DEPARTMENT  
COUNTY OF SAN BERNARDINO  
CALIFORNIA  
CA 03600**

Dr# 1331036-07  
H# 100-85  
REPORT AREA

Page 2

SECTION pc 187	CRIME Murder	CLASSIFICATION Felony
VICTIM'S NAME - LAST NAME	FIRST NAME	MIDDLE NAME
ADDRESS		PHONE
RESIDENCE		
(FIRM NAME IF BUSINESS)		

**TAG #B67999: (From east corner of bed beneath comforter)**

**Microscopic Slide Box**

- Item B4F - Standard head hair
- Item B4D - Standard pubic hair
- Item A18 - Possible pubic hair from felt pad
- Item A17 - Hair from gag
- Item A16 - 1, 2, 3 hair
- Item A5 - 1-8 and 1 hair with root
- Item A4 - 7 slides with hair
- Item A1 - 8 slides, 1 with root

- Item A17 - (1) White pant used as a gag
- Item A18 - (1) Brown and tan felt desk pad
  - (1) Tan bra "Equisite" form in group 384 size 36B
  - (1) Red pair of shorts "Lady La Mode" active sports wear size 8
  - (1) Blue blazer button up "Phil Carry" size 12
  - (2) White pillow cases with colored flower designs

- Item B3 - (1) Metal coat hanger
- Item A3 - (1) Panty
- Item B2 - (1) Tissue from victim's chin
- Item B5 - Victim's dentures

- Item A15 - Watch band keeper (west of victim's head beneath pillow)
- Item B1 - Loose Hair(s) from victim's torso
- Item A22 - Standard from carpet
- Item A4 - Vacuum sweepings from area east of bed
- Item A16 - Vacuum sweepings from bedding
- Item A1 - Vacuum sweepings of carpet inside doorway and hair from vacuum
- Item A5 - Vacuum sweepings south and west side of bed
- Item A-6 thru A-10 - Tape lift of victim's torso

*IN  
SAME  
BAG*

*DETECTIVE  
DID  
TESTIFY THAT  
THE EVID. WAS  
BAGGED  
TOGETHER*

REPORTING OFFICER Greg Myler	DATE 01/15/2009	REVIEWED BY	TYPED BY	ROUTED BY	DATE
THEIR ACTION: <input type="checkbox"/> NO	COPIES TO: <input type="checkbox"/> Detective <input type="checkbox"/> Dist. Atty.	<input type="checkbox"/> Other <input type="checkbox"/> CII <input type="checkbox"/> Patrol	<input type="checkbox"/> SD/PD <input type="checkbox"/> Other	REMARKS	

# EXHIBIT COVER PAGE

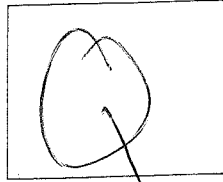

EXHIBIT

DESCRIPTION OF THIS EXHIBIT:

NUMBER OF PAGES TO THIS EXHIBIT: 4 PAGES

JURISDICTION: (CHECK ONLY ONE)

- MUNICIPAL COURT
- SUPERIOR COURT
- APPELLATE COURT
- STATE SUPREME COURT
- UNITED STATES DISTRICT COURT
- STATE CIRCUIT COURT
- UNITED STATES SUPREME COURT
- GRAND JURY

**SHERIFF'S DEPARTMENT  
COUNTY OF SAN BERNARDINO  
CALIFORNIA  
CA 03600**

Page 1

CASE NO.  
Dr# 1331036-07  
H# 100-85  
REPORT AREA

SECTION <b>Pc 187</b>	CRIME <b>Murder</b>	CLASSIFICATION <b>Felony</b>
VICTIM'S NAME - LAST NAME		(FIRM NAME IF BUSINESS)
FIRST NAME		MIDDLE NAME
ADDRESS	RESIDENCE	PHONE

**EVIDENCE VIEWED AND PHOTOGRAPHED ON 01/14/2009:**

On Wednesday, January 14<sup>th</sup>, 2009, at approximately 1510 hours, I viewed and photographed the evidence for this case in a conference room at the San Bernardino County Sheriff's Department's Property Division.

*NEVER HAD PAD TESTED FOR OTHER DNA'S*

- TAG # B22559:**
- (1) Felt pad
  - (1) Bed sheet

- TAG # B68345:**  
**Item #A2**
- (1) Blue long sleeve "Wrangler" shirt size large
  - (1) yellow/white striped cotton towel "Cannon" brand
  - (1) White cotton towel
  - (2) White kitchen towels with apples and water spout designs
  - (1) White and yellow face towel
  - (1) Kitchen towel with fruit designs
  - (1) Multi colored dish towel
  - (1) Blue towel "Sears" brand
  - (2) Tan bras "Equisite" brand size 36B
  - (1) Blue "Sassoon" jeans size 9 JR with a red belt
  - (1) White short sleeve t-shirt with red stars size medium.
  - (1) Peach colored sweat pants "Summit Sport Wear" size 6
  - (1) Tan colored sandals "Candie" brand size 10
  - (1) Blue flip flops with rainbow colors
  - (1) Blue cotton towel

- TAG # B68345**  
**Item #A13**
- (1) Blue pillow
  - (1) Blue pillow (from beneath the victim's head - vacuumed)

REPORTING OFFICER <b>Greg Myler</b>	DATE <b>01/15/2009</b>	REVIEWED BY	TYPED BY	ROUTED BY	DATE
OTHER ACTION: <input type="checkbox"/> NO	COPIES TO:	<input type="checkbox"/> Other	<input type="checkbox"/> SD/PD	REMARKS	
	<input type="checkbox"/> Detective	<input type="checkbox"/> CII	<input type="checkbox"/> Other		
	<input type="checkbox"/> Dist. Atty.	<input type="checkbox"/> Patrol			

*142*  
409



NOT TO SCALE  
 DR 1331036-07  
 COBB, RITA  
 R.T. MCCOY M13B4

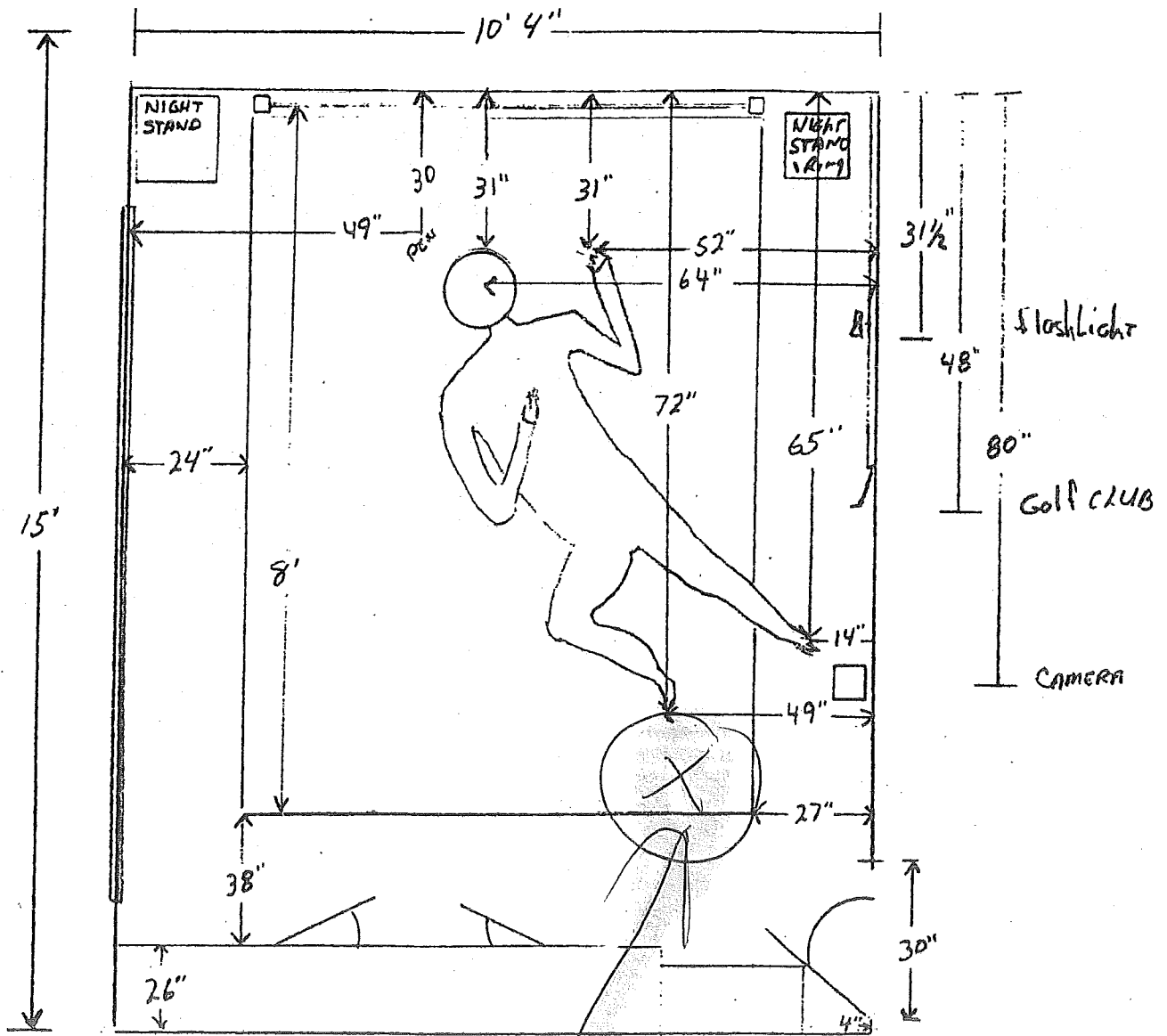

FELT PAD  
 UNDER  
 COMFORTER  
 NOT UNDER BODY  
 AS ATTY DDA FERGUSON  
 STATED IN THE  
 ARGUMENT OFF  
 IN FERMAR

DA

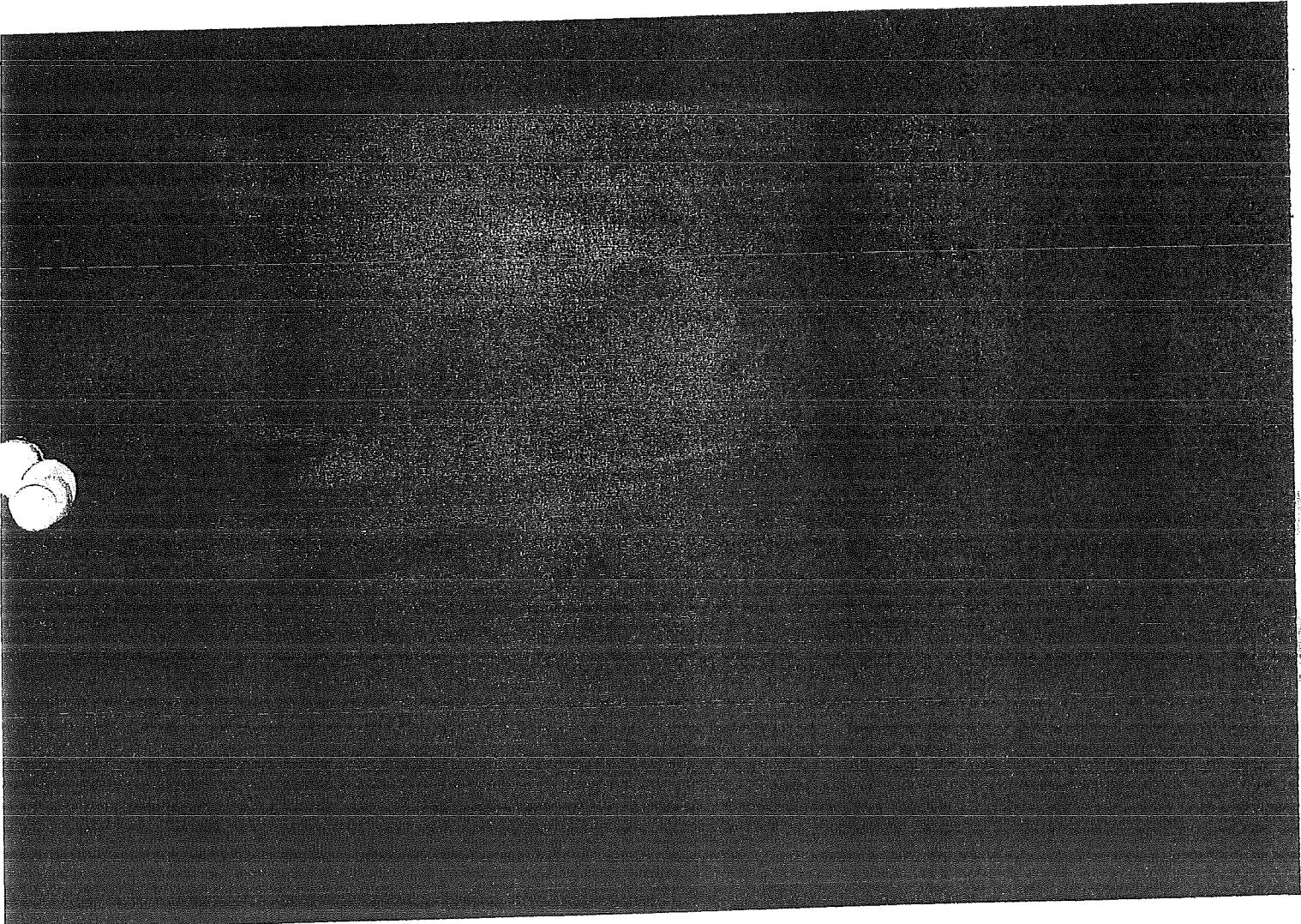

Hand kept file

# EXHIBIT COVER PAGE

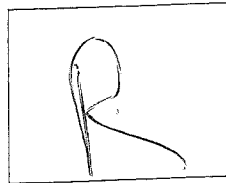

EXHIBIT

DESCRIPTION OF THIS EXHIBIT:

NUMBER OF PAGES TO THIS EXHIBIT: 3 PAGES

JURISDICTION: (CHECK ONLY ONE)

- MUNICIPAL COURT
- SUPERIOR COURT
- APPELLATE COURT
- STATE SUPREME COURT
- UNITED STATES DISTRICT COURT
- STATE CIRCUIT COURT
- UNITED STATES SUPREME COURT
- GRAND JURY

76

BRUCE NASH  
STATEMENTS  
BUT LIED ON STAND

THIS WATO TESTIFIED  
VIC WAS GOING HOME AFTER  
PARTY, NOT TO BAR, BUT  
IN 85, 2009, HE MADE REPORTS TO  
BAR, IN 2010 SHE WAS GOING TO A  
HE TOLD BAR SHE WAS GOING TO A  
LIED ON FEB 2011

1/6510  
DEF. INVESTIGATOR  
LIED ON FEB 2011  
STAND

1 told Ms. Cobb that he would drive her home but she told him that she would drive herself  
2 and that she was going to go to a bar. (p. 270-271)

3 While the detectives were still at the scene they were approached by Joseph  
4 Saunders. Detective Knapp spoke to him. Saunders claimed that Ms. Cobb had asked him  
5 out a few months before her death. He also described other social events they had attended  
6 and then mentioned that he was at her house the Friday before her death. According to him  
7 she had asked him to go with her to Sullivan's to pick pistachios. He agreed to go and met  
8 her there. He said she was drinking. (p. 78-79) The next morning Mr. Saunders was  
9 reinterviewed by Detective Woods. He was talking about how he had come over to her  
10 house and while talking he started to cry. The detective stated that he was crying  
11 "violently." He gave a somewhat different version of the evening of the 20<sup>th</sup>, (Friday) and  
12 said that as he was leaving Ms. Cobb came out and said it was okay with her if he wanted  
13 to stop by later that night. Mr. Saunders claims that he declined. At that point he started to  
14 cry again. (p. 110-111) Interestingly, just days after the death of Ms. Cobb, Mr. Saunders  
15 wrote a will and then he committed suicide. (p.146)

16 Interestingly, A man named William Backoff contacted Detective Tuttle two days  
17 after the body was found. He said he heard the police were looking for him. Detective  
18 Tuttle said he was not informed that anybody was looking for Mr. Backoff. Backoff told  
19 something about being at Ms. Cobb's house a couple of weeks before her death. He also  
20 said he had dated her but he denied having sex with her. (p. 66-67)

21 Three years later Detective Palacios was doing a followup on Mr. Backoff. He went  
22 to Backoff's home and tried to interview him but was unsuccessful as Mr. backoff was  
23 drinking at the time. Mr. Backoff did complain to the detectives that they were not doing  
24 their duty as they had not yet caught whoever killed Ms. Cobb. The next day Mr. Backoff  
25 was interviewed at the sheriff's station. He said that he was once arrested for DUI because  
26 of Ms. Cobb. He also spoke of how he had a girlfriend who gave a room divider to Ms.  
27 Cobb and how his girlfriend's two boys were angry about that. Interestingly, all through  
28

MIRRE KNEW  
MIRRE INFORMATION  
DIDN'T  
USED TO  
WEST 16 APR 22  
PRESERVE  
OR  
APPEALS

11/6

78

91  
166

HERE IS WHO'S  
THE GOLD WATCH PIN  
WAS LIKELY TO COME  
FROM

1 The detectives next called on the former boyfriend, Fred Bedard. He told Detective  
2 Woods that he had lived with Ms. Cobb for a short period of time and that they had often  
3 had altercations when she would be drinking. The detectives noted that Mr. Bedard wore a  
4 watch made of yellow metal. (p. 108)

GOLD WATCH PIN???

5 Angela Neete, Ms. Cobb's boss at the Silver Lake County Club admitted to  
6 Detective Woods that Ms. Cobb had social relationships with at least three males at the  
7 country club.

8 Bud Turner told Detective Woods that he was almost positive that he had seen Ms.  
9 Cobb at a store in Lucerne Valley on Saturday, the 21<sup>st</sup>. (p. 115) Later Sherman Anderson  
10 told Detective McCoy that while driving his work vehicle, a water truck, he had passed  
11 Ms. Cobb's house several times in the week before her body was found. He said on four or  
12 five occasions that week he saw a stranger, a male, in her front yard acting very strangely,  
13 waving a stick and yelling at the truck as he went by. (p. 128)

14 Ms. Cobb kept an address book which was obtained by the sheriff's department  
15 after her death. The address book had the names and phone numbers of many people but  
16 also the names and phone numbers of 19 men who's names otherwise do not appear in any  
17 of the reports of people that were interviewed by the sheriff's department. (p. 165-217)

WHERE ARE THEY NOW??

INCOMPETANT  
ATTORNEY

JOSEPH NOT JOHN

18  
19  
20  
21 Ten of the necessary witnesses are confirmed deceased, including John Saunders,  
22 William Backoff, Betty Ball, Sherm Anderson, Ed Liebe, Glen Moritz, Bruce Lee, and Ed  
23 Wight. Four witnesses have not been found and it is unknown if they are dead or alive,  
24 including Frank Stroup, Robert Edwards, Audrey Scroggins, and David Leftwich. Five  
25 witnesses may or may not be in the area but defendant is unable to tell, that being Doris

IN PRISON  
SANGUENIN

HE TOLD SANDERS  
HE WAS IN VICTORVILLE

26 Jackson, Fred Holbrook, Dawn Dinsmore, Rebecca Townsend, and Dianne Flag-

SHE IS ALIVE  
IN OCEANS  
WASH DC

TESTIFIED  
AT TRIAL

27  
28

You KNEW WHERE THESE PEOPLE WERE BUT STILL  
DID NOT INVESTIGATE OR INTERVIEW  
Speedy Trial Motion, YABLONSKY

118

SHERIFF'S DEPARTMENT

County of San Bernardino  
California  
CA 03600

CASE NO. DR 1331036-07
REPORT AREA

MODE SECTION PC 187	CRIME MURDER	CLASSIFICATION
VICTIM'S NAME - LAST NAME COBB,	FIRST NAME RITA	MIDDLE NAME (FIRM NAME IF BUSINESS)
ADDRESS	<input type="checkbox"/> RESIDENCE <input type="checkbox"/> BUSINESS	PHONE ( )

Page 2

CRIME SCENE: (Continued)

has changed to a brown-green color and has swollen. The victim's false teeth have protruded from her mouth and her uppers are present and the lower plate was lying on the bed next to her. There is a white cloth present in the victim's mouth which was possibly used as a gag.

Located on the top of the bedding near the victim's head was a wrist watch, brand Pen. This item was collected by Sheriff's Crime Lab personnel. Located on the floor of the bedroom near the foot of the bed adjacent to the north wall of the bedroom was a number of women's clothing. These items were collected by Sheriff's Crime Lab personnel. The bedding from the bed was removed after the body had been removed and also was collected by Sheriff's Crime Lab personnel.

Also located in the crime scene search were two drops of blood indicated in the crime scene drawing as A24 and A23. Drop A24 was located on the molding of the doorway leading from the hall of the residence into the bedroom in which the victim was located. This drop of blood is located on the molding of the door which leads from the hallway into the bedroom where the victim was located. This blood drop is located approximately 43 inches from the floor of the hallway and is located on the south wall of the hallway. Blood drop indicated as A23 is located on the wall which separates the hallway of the dining area and the bathroom area. This drop of blood is located on the narrow portion of the hallway and is approximately 35 inches above the floor of the hallway. Samples of both of these blood droppings were taken by Sheriff's Crime Lab personnel for analysis.

Located in the dining area of the residence is a desk which is located against the south wall of the dining area. Present on the top of this desk was an ashtray which contained cigarette butts, indicated in Sheriff's photographs by a number 5. Samples of these cigarette butts were taken by Sheriff's Crime Lab personnel. Also located on the desk was a package of Benson and Hedges Cigarettes. Also located in the dining area is a round table which stood soft drink containers and a package of Virginia Slims Cigarettes.

FREE BEDDING

THIS WAS NOT TESTED

REPORTING OFFICERS MC COY, Det. M1384	DATE 10-3-85	REVIEWED BY	TYPED BY CP P1786	ROUTED BY	DATE	
OTHER ACTION: YES <input type="checkbox"/> NO <input type="checkbox"/>	COPIES TO: <input type="checkbox"/> Detective <input type="checkbox"/> Dist. Atty.	<input type="checkbox"/> SD/PD <input type="checkbox"/> CII <input type="checkbox"/> Patrol	<input type="checkbox"/> Other <input type="checkbox"/> Other	REMARKS		

# EXHIBIT COVER PAGE

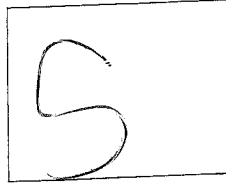

EXHIBIT

DESCRIPTION OF THIS EXHIBIT:

NUMBER OF PAGES TO THIS EXHIBIT: 7 PAGES

JURISDICTION: (CHECK ONLY ONE)

MUNICIPAL COURT

SUPERIOR COURT

APPELLATE COURT

STATE SUPREME COURT

UNITED STATES DISTRICT COURT

STATE CIRCUIT COURT

UNITED STATES SUPREME COURT

GRAND JURY



1 DOREEN B. BOXER  
Public Defender  
2 LAURI FERGUSON  
Assistant Public Defender, Main Unit  
3 By: DAVID SANDERS  
State Bar # 78021  
4 Deputy Public Defender  
14344 Cajon Ave. St. 201  
5 Victorville, CA 92392  
760-241-0413

6  
7 *Attorney for Defendant, John Henry Yablonski*

8  
9 **SUPERIOR COURT OF THE STATE OF CALIFORNIA**  
10 **COUNTY OF SAN BERNARDINO, DESERT DIVISION**

11  
12 PEOPLE OF THE STATE OF CALIFORNIA,  
13 *Plaintiff,*  
14  
15 vs.  
16 JOHN HENRY YABLONSKI  
17 *Defendant.*

) Case No.: FVI 900518

) NOTICE OF MOTION TO  
) COMPEL DISCOVERY; POINTS,  
) AUTHORITIES AND ARGUMENT  
) IN SUPPORT THEREOF;  
) PROPOSED ORDER FOR  
) DISCOVERY; DECLARATION OF  
) COUNSEL.

18  
19 **PLEASE TAKE NOTICE** that on October 8th, 2010, at 8:30 a.m., or as soon  
20 thereafter as the matter may be heard in Department V-2 of the above-entitled Court,  
21 defendant John Yablonski will move the Court for an order directing the prosecution to  
22 comply with the attached proposed **ORDER FOR DISCOVERY**.

23  
24 Said motion is based on all papers in the Court's file, the transcript of the  
25 preliminary examination, these moving papers, any exhibits incorporated herein by  
26 reference and admitted at the hearing, the testimony of any witnesses presented at the  
27  
28

1 hearing, Points, Authorities, and Arguments and any argument of counsel at the hearing  
2 hereon.

3  
4 STATEMENT OF THE CASE

5  
6 Defendant is charged by way of felony information with the premeditated murder of  
7 Rita cob. It is further alleged that the crime was committed in the course of a rape. On  
8 March 17<sup>th</sup>, 2009, Deputy Public Defender Geoffrey Canty served an Informal request for  
9 discovery on the assigned prosecutor, Deputy District Attorney John Thomas. (A copy of  
10 said request is attached as Exhibit A to the attached declaration of counsel.) Thereafter, on  
11 November 2<sup>nd</sup>, 2009, the undersigned sent an additional Informal Request for Discovery to  
12 Mr. Thomas. (A copy of this request is attached as Exhibit B to the Declaration of  
13 Counsel.)

14  
15 STATEMENT OF ANTICIPATED FACTS

16  
17 On September 23<sup>rd</sup>, 1985, Daryl Kraemer and his then-girlfriend, now-wife, Marta  
18 Simon, drove to the home of Daryl's mother, Rita Cobb. They arrived at about 11:30 a.m.  
19 and found the nude body of Ms. Cobb in her bedroom. (p. 4)<sup>1</sup>

20  
21 In the ensuing months the Sheriff's Department interviewed dozens of witnesses  
22 with some knowledge of the crime or the victim. They also investigated the death of Helen  
23 Brooks, a woman who was killed in the same general area as Ms. Cobb and in a similar  
24 fashion. In fact, the Sheriff sent out requests for assistance to outside law enforcement  
25 agencies in which the murders of the two women were suggested to be the work of the  
26

27  
28 <sup>1</sup> All page numbers reference the discovery numbering system used by the DA and defense counsel.

1 same person. Thereafter the sheriff also linked the death of Ms. Cobb to investigations into  
2 the deaths of four other women, Deeble, Belcher, Gibbons, and Kreismanis.

3  
4 One suspect in the death of Ms. Cobb was a person by the name of George  
5 Randolph. In the Sheriff's reports they refer to him by the name of William backoff for  
6 some reason that is not apparent to counsel. It could be that he was a county employee,  
7 perhaps an officer in the coroner's office and that he was found to possess the photographs  
8 of a number of deceased women. He is reported to have killed himself sometime after the  
9 murder of ms. Cobb.

10  
11 The prosecutor hs announced his intention to use as 1101b evidence alleged  
12 instances involving two witnesses, Sun Kye and Lori Amaro. Defendant needs the current  
13 contact information to investigate these allegations.

14  
15  
16 **POINTS AUTHORITIES AND ARGUMENT**

17  
18 "A...defendant's right to discovery is based on the fundamental proposition that [an  
19 accused] is entitled to a fair trial and an intelligent defense in light of all relevant and  
20 reasonably accessible information." *Santa Cruz v Municipal Court* (1989) 49 Cal 3d 74,  
21 84.

22  
23 Defense discovery begins with Penal code section 1054.1: "the prosecutin attorney  
24 shall disclose to the [defense] all of the following materials and information, if it is in the  
25 possession of the prosecution attorney or if[he] knows it to be in the possession of the  
26 investigation agencies: ... (c) All relevant real evidence seized or obtained as part of the  
27 investigation of the offenses charged. ... (e) Any exculpatory evidence....  
28

1  
2  
3  
4  
5  
6  
7  
8  
9  
10  
11  
12  
13  
14  
15  
16  
17  
18  
19  
20  
21  
22  
23  
24  
25  
26  
27  
28

“While it is true the prosecution ‘has no general duty to seek out, obtain, and disclose all evidence that might be beneficial to the defense, to satisfy the specific discovery provisions of section 1054 et seq.’ *People v Little* (1997) 59 CA 4<sup>th</sup> 426,432.

In *Izazaga v Superior Court* (1991) 54 C3d 356, 378, the Court stated that the defense is entitled to a broad range of discovery not specifically spelled out in the statutory language. “In order that a defendant may secure a fair trial as required by the due process clause, the prosecution has a duty to disclose all substantial material evidence favorable to the accused.... That duty exists regardless of whether there has been a request for such evidence. The... duties of disclosure under the due process clause are *wholly independent* of any statutory scheme of reciprocal discovery. The due process requirements are self-executing and need no statutory support to be effective. “

CONCLUSION

For all the above stated reasons, defense requests that this court compel discovery as requested in the proposed ORDER FOR DISCOVERY.

DATED: September 23rd, 2010

Respectfully submitted,



DAVID L. SANDERS  
Deputy Public Defender

94  
169

1 DOREEN B. BOXER  
Public Defender  
2 LAURI FERGUSON  
Assistant Public Defender, Main Unit  
3 By: DAVID SANDERS  
State Bar # 78021  
4 Deputy Public Defender  
14344 Cajon Ave. St. 201  
5 Victorville, CA 92392  
760-241-0413  
6

7 Attorney for Defendant, John Henry Yablonski

8 SUPERIOR COURT OF THE STATE OF CALIFORNIA  
9 COUNTY OF SAN BERNARDINO, DESERT DIVISION  
10

11 PEOPLE OF THE STATE OF CALIFORNIA,  
12 Plaintiff,  
13  
14  
15 vs.  
16 JOHN HENRY YABLONSKI  
17 Defendant.

Case No.: FVI 900518  
PROPOSED ORDER FOR  
DISCOVERY

18  
19 PLEASE TAKE NOTICE that after due consideration of the facts and the law **IT**  
20 **IS ORDERED** that the District Attorney provide the following items of discovery to the  
21 defendant as soon as possible but not later than the 15<sup>th</sup> of October, 2010.

- 22 1. All police reports, investigations and lab work completed during the  
23 investigation of the death of Helen Brooks.  
24 2. All notes and reports created in the investigation of and death of George  
25 Randolph/William Backoff.  
26 3. Any police reports regarding the death of Joseph Saunders.  
27 4. All police reports of the investigation of the death of Meryl gibbs.  
28

128

- 1 5. Complete criminal investigations regarding the deaths of Deeble, Belcher,
- 2 Gibbons, and Kreismanis.
- 3 6. Contact information for Sun Kye and Lori amaro.
- 4 7. Current contact information or death information regarding betty Ball, Audrey
- 5 Scroggins, John Sullivan, Francesca Drake, Bruce Nash, Cynthia Nash, Dave
- 6 Leftwich, Doris Jackson, Fred Hollbrook, Rene Smith, Dawn Dismore, Sheryl
- 7 Broaddeus, Rebecca Townsend, Dianne Flagg, Don Stowe, Sherman Anderson,
- 8 Carol Tevis, Bud Turner, Ed Liebe, Glen Moritz, Bruce Lee, and Ed Wright or
- 9 Wight.
- 10 8. The current contact information for all the police or sheriff personel who took
- 11 part in the investigation of this matter.

BRUCE NASH (LIED ON STAND)  
JOHN SULLIVAN

It is so ordered.

- 14 (A) JOHN SULLIVAN TESTIFIED AT TRIAL
- 15 (B) BRUCE NASH AT TRIAL
- 16 (C) CYNTHIA NASH WAS AT TRIAL
- 17 (D) FRANCESCA WAS AT TRIAL

Judge of the Superior Court

(1) I TOLD SANDER DAVE LEFTWICH WAS IN VICTORVILLE, GAVE HIM AN ADDRESS AND PHONE NUMBER.

(2) DIANNE FLAG TESTIFIED SEEING A SILVER PINTO

(3) ROBERT EDWARDS IS IN SAN QUENTIN ON DEATH ROW FOR IDENTICAL CASE !!

( I INFORMED SANDERS OF THESE PERSONS WHERE THEY WERE, BUT HE NEVER MADE EFFORTS TO INVESTIGATE !! )

How does a deputy go from county jail employee to homicide detective 18 months later, where did his training come from, didn't somebody tell him to not lie and not alter evidence why is he back as a county jail bailor? and a sergeant

98

1/13

Sanders, David

STILL ACTIVE AS LEAD INVESTIGATOR

PERJURER

From: Alexander, Robert [ralexander@sbcisd.org]  
Sent: Thursday, January 13, 2011 9:06 AM  
To: Sanders, David  
Cc: Thomas, John  
Subject: Contact info for DR 1331036-07

MY TRIAL STARTED JAN 19 2011

THIS IS A POSSIBLE WRONG ADDRESS

1. [Redacted] (372) [Redacted] home phone

2. [Redacted] home phone  
315 Pearson Drive, apt #1  
Porterville, Ca. 93257

THIS IS A POSSIBLE WRONG ADDRESS

THIS IS ONLY 6 DAYS TILL TRIAL STARTS

Det. Alexander  
ralexander@sbcisd.org  
909-387-3556 (Desk)  
909-387-3455 (Fax)

ON JAN 14 2011 SANDERS (CITY TRIAL) ANNOUNCED READY FOR TRIAL WITHOUT ONE CALL TO THESE WITNESSES. THIS IS A BRADY VIOLATION BEING THESE PEOPLE WERE ON THESE ATTORNEYS WITNESS ROSTER

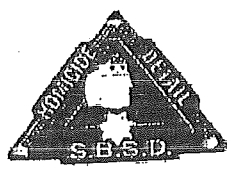

THE REQUEST FOR THIS WAS 60 DAYS PRIOR YET THIS WAS GIVEN ONLY DAYS BEFORE TRIAL STARTED

THIS IS A BRADY VIOLATION BEING THESE PEOPLE WERE ON THESE ATTORNEYS WITNESS ROSTER WHERE IS A COMPETANT ATTORNEY

132

# EXHIBIT COVER PAGE

52

EXHIBIT

DESCRIPTION OF THIS EXHIBIT:

NUMBER OF PAGES TO THIS EXHIBIT: 3 PAGES

JURISDICTION: (CHECK ONLY ONE)

MUNICIPAL COURT

SUPERIOR COURT

APPELLATE COURT

STATE SUPREME COURT

UNITED STATES DISTRICT COURT

STATE CIRCUIT COURT

UNITED STATES SUPREME COURT

GRAND JURY



SHERIFF'S DEPARTMENT  
 COUNTY OF SAN BERNARDINO  
 CALIFORNIA  
 CA 03600

CASE NO.  
 DR #1331306-07  
 H #100-85  
 REPORT AREA  
 Lucerne Valley, Ca.

Page 1

CODE SECTION PC 187	CRIME MURDER	CLASSIFICATION Stabbing
VICTIM'S NAME - LAST NAME Cobb	FIRST NAME Rita	MIDDLE NAME
ADDRESS	RESIDENCE	PHONE

**CONTACT:** Victim #1 Long Beach Police Department, report #960239715  
**Information:** During the investigation I ran a criminal history on John Yablonski and found he had two prior arrests for rape. The first arrest occurred in 1982, in El Paso Texas. I contacted the El Paso Police Department and obtained a copy of the police report. The second arrest occurred in 1996, in Long Beach California. I contacted the Long Beach Police Department and obtained a copy of the police report.

John was arrested for other crimes such as drugs and burglary and I attempted to obtain a copy of the burglary reports but found the reporting agency(s) had purged the reports.

**Contact:** After obtaining the rape reports I used police computer programs to search and locate the victims listed in each report.

On November 17, 2010, I spoke with Victim #1 via telephone and did not record the conversation. I explained I worked for the San Bernardino County Sheriff's Department, Cold Case Unit and was trying to locate Victim #1 who lived in Long Beach in the mid 1990's. Additionally, I was looking for someone who reported to the Long Beach Police Department she was the victim of a sexual crime.

Victim #1 confirmed she was the person I was looking for. She briefly dated a man named John Yablonski and broke off the relationship because he was violent and using drugs. We did not discuss the rape report or the facts of the rape report. I explained John Yablonski had been arrested for committing a murder in Lucerne Valley and was currently in jail, awaiting trial.

I told Victim #1 during trial we would like to have victims of other sexual crimes committed by Yablonski, testify in court regarding what happened to them. Victim #1 said she understood and was willing to assist us if needed. I told her the trial could happen soon or be many months away.

After obtaining her current contact information, I ended the conversation.

*WHERE ARE RECORDED TRANSCRIPTS  
 DET. ALEXANDER HAS HISTORY OF ALTERING EVIDENCE AND LYING*

REPORTING OFFICER ALEXANDER	#A1672	DATE 11-18-2010	REVIEWED BY	TYPED BY	ROUTED BY	DATE
HER ACTION: <input type="checkbox"/> YES <input type="checkbox"/> NO	COPIES TO: <input type="checkbox"/> Detective <input type="checkbox"/> Dist. Ally.	<input type="checkbox"/> Other <input type="checkbox"/> CII <input type="checkbox"/> Patrol	<input type="checkbox"/> SD/PD <input type="checkbox"/> Other	REMARKS		

THIS WAS MY EX FIANCÉ, I JUST MOVED OUT THAT DAY BEFORE

THIS MAN ALEXANDER HAS DOCTORED EVIDENCE AND LIED ON STAND  
 THIS WAS NEVER FILED, DISMISSED BY INVESTIGATOR AND A PERMANENT RESTRAINING ORDER WAS GIVEN TO YABLONSKI AGAINST AMARO THROUGH COURTS, NO ATTEMPT TO RETRIEVE THIS DATA WAS MADE BY SANDERS I TOLD HIM THEY ERASE

ON THE STAND, ALL AGENCY CALLS ARE RECORDED THROUGH AGENCY PHONE SYSTEM, WHERE ARE THESE TRANSCRIPTS, IT IS BELIEVED THAT THIS DOCUMENT

109  
188

145

112

SHERIFF'S DEPARTMENT  
COUNTY OF SAN BERNARDINO  
CALIFORNIA  
CA 03600

Page 1

CASE NO.  
DR #1331306-07  
H #100-85  
REPORT AREA  
Lucerne Valley, Ca.

CODE SECTION PC 187	CRIME MURDER	CLASSIFICATION Stabbing
VICTIM'S NAME - LAST NAME: Cobb		(FIRM NAME IF BUSINESS)
FIRST NAME: Rita	MIDDLE NAME:	PHONE:
ADDRESS: RESIDENCE		

**CONTACT:** Victim #1 El Paso Texas Report #01-21045L

**Information:** During the investigation I ran a criminal history on John Yablonski and found he had two prior arrests for rape. The first arrest occurred in 1982, in El Paso Texas. I contacted the El Paso Police Department and obtained a copy of the police report. The second arrest occurred in 1996, in Long Beach California. I contacted the Long Beach Police Department and obtained a copy of the police report.

John was arrested for other crimes such as drugs and burglary and I attempted to obtain a copy of the burglary reports but found the reporting agency(s) had purged the reports.

**Contact:** After obtaining the rape reports I used police computer programs to search and locate the victims listed in each report.

On November 17, 2010, I spoke with Victim #1 via telephone and did not record the conversation. I explained I worked for the San Bernardino County Sheriff's Department, Cold Case Unit and was trying to locate Victim #1 who lived in El Paso, Texas in 1982. Additionally, I was looking for someone who reported to the El Paso Police Department she was the victim of a sexual crime.

Victim #1 confirmed she was the person I was looking for. She worked at a bar in El Paso, Texas and was raped by a man while at work. We did not discuss the rape report or the facts of the rape report.

I explained to Victim #1 the person who sexually violated her had been arrested for committing a murder in Lucerne Valley and was currently in jail awaiting trial. We talked for a few minutes then Victim #1 told me she had to go to work and wanted me to contact her later. She requested I have a Korean interpreter with me the next time I called her. She said many years had passed since the incident she was involved in and would feel more comfortable talking to me in her native language.

At approximately 1430 hours, I receive a telephone call from Det. Richard Kim of the Federal Way Police Department who is fluent in Korean. Richard said Victim #1 was in his

WHERE ARE AGENCY TRANSCRIPTS OF ALEXANDER ON STAND ABOUT EVIDENCE, ALL CALLS ARE RECORDED THROUGH AGENCY PHONE SYSTEM, WHERE ARE THOSE TRANSCRIPTS? IT IS BELIEVED THIS DOCUMENT WAS BOLSTERED BY ALEXANDER.

REPORTING OFFICER ALEXANDER	#A1672	DATE 11-18-2010	REVIEWED BY	TYPED BY	ROUTED BY	DATE
OTHER ACTION: <input type="checkbox"/> YES <input type="checkbox"/> NO	COPIES TO: <input type="checkbox"/> Detective <input type="checkbox"/> Dist. Atty.	<input type="checkbox"/> Other <input type="checkbox"/> CII <input type="checkbox"/> Patrol	<input type="checkbox"/> SD/PPD <input type="checkbox"/> Other	REMARKS		

THE LADY THAT CAME OUT OF BAR CRYING, SAYING I COMMITTED THIS ACT WAS NOT THE HOOKER I PAID THE \$20 TO, WHILE HER PIMP WANTED 40. SHE REFUSED TO PAY ANY MORE. A DEPOSITION WAS RECORDED.

113  
188

SHERIFF'S DEPARTMENT  
COUNTY OF SAN BERNARDINO  
CALIFORNIA  
CA 03600

Page 2

CASE NO.  
DR #1331306-07  
H #100-85  
REPORT AREA  
Lucerne Valley, Ca.

CODE SECTION PC 187	CRIME MURDER	CLASSIFICATION Stabbing
VICTIM'S NAME - LAST NAME Cobb		(FIRM NAME IF BUSINESS)
FIRST NAME Rita	MIDDLE NAME	PHONE
ADDRESS	RESIDENCE	

office and wanted him to contact me on her behalf. Richard placed the telephone on speaker phone then translated to Victim #1 was we spoke. I could hear the conversation but could not understand Korean.

I told Richard during trial we would like to have victims of other sexual crimes committed by her assailant testify in court regarding what happened to them. Richard translated to Victim #1 who said she understood and was willing to assist us if needed. I told Richard the trial could happen soon or be many months away.

After obtaining Victim #1's current contact information, I ended the conversation.

DET. ALEXANDER HAS HISTORY  
OF ALTERING EVIDENCE IN THIS CASE  
AND LYING ON STAND ABOVE EVIDENCE.

REPORTING OFFICER ALEXANDER	#A1672	DATE 11-18-2010	REVIEWED BY	TYPED BY	ROUTED BY	DATE
OTHER ACTION: <input type="checkbox"/> YES <input type="checkbox"/> NO	COPIES TO: <input type="checkbox"/> Detective <input type="checkbox"/> Dist. Atty.	<input type="checkbox"/> Other <input type="checkbox"/> CII <input type="checkbox"/> Patrol	<input type="checkbox"/> SD/PD <input type="checkbox"/> Other	REMARKS		

# EXHIBIT COVER PAGE

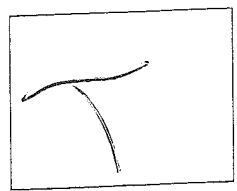

EXHIBIT

DESCRIPTION OF THIS EXHIBIT:

NUMBER OF PAGES TO THIS EXHIBIT: 4 PAGES

JURISDICTION: (CHECK ONLY ONE)

- MUNICIPAL COURT
- SUPERIOR COURT
- APPELLATE COURT
- STATE SUPREME COURT
- UNITED STATES DISTRICT COURT
- STATE CIRCUIT COURT
- UNITED STATES SUPREME COURT
- GRAND JURY

1 DOREEN B. BOXER  
 Public Defender  
 2 LAURI FERGUSON  
 Assistant Public Defender, Main Unit  
 3 By: DAVID SANDERS  
 State Bar # 78021  
 4 Deputy Public Defender  
 14344 Cajon Ave. St. 201  
 5 Victorville, CA 92392  
 760-241-0413

6  
 7 *Attorney for Defendant, John Henry Yablonski*

8  
 9 SUPERIOR COURT OF THE STATE OF CALIFORNIA  
 10 COUNTY OF SAN BERNARDINO, DESERT DIVISION

11  
 12 PEOPLE OF THE STATE OF CALIFORNIA,  
 13 *Plaintiff,*  
 14  
 15 vs.  
 16 JOHN HENRY YABLONSKI  
 17 *Defendant.*

Case No.: FVI 900518  
 DECLARATION OF DAVID SANDERS

18  
 19 Comes Now David Sanders and affirms and declares that he is an attorney at law,  
 20 licensed to practice in all courts of the State of California, and the attorney for defendant in  
 21 this matter, and that he has personal knowledge of the matters herein stated so that he could  
 22 competently testify.

23  
 24 Under penalty of perjury I declare that:

- 25 1. I took over the management of this matter may of 2009. When I reviewed the  
 26 file I noted that the prior attorney had emailed the prosecutor asking for  
 27 discovery as evidenced by exhibit A attached to this motion.

- 1 2. I also made an informal emailed request for discovery as evidenced by exhibit B
- 2 attached to this motion.
- 3 3. To date I have had no response from the prosecutor as to the items I have
- 4 requested.
- 5 4. The prosecutor has kindly invited me to review the documents in his file
- 6 regarding the murder of Helen Brooks but I have been provided none of the
- 7 documents in that case.
- 8 5. I need all of the requested items to adequately prepare for trial in this matter.

October 5<sup>th</sup>, 2010

David L. Sanders

THIS IS A DECLARATION OF FIDUCIARY  
 DUTY TO CLIENT, YET HE "ALWAYS" LIED  
 TO ME, NEVER DISCUSSED ANY STRATEGY, MOTIONS,  
 EVIDENCE, WITNESSES. WHEN I SPOKE TO PACU THE  
 INVESTIGATOR HE SAID HE WAS NOT TO LISTEN TO  
 ME, AND ANY QUESTIONS WERE TO BE DIRECTED TO  
 ATTORNEY. . . . WHO NEVER VISITED TO DISCUSS,  
 ANSWERED LETTERS, PHONE CALLS, BUT I BOT HE  
 CASHED HIS CHECK. AT REELECTION STUNS I  
 ASKED HIM, HOW MANY FLYER WERE MAILED, HE SAID  
 THREE THOUSAND, THAT HE ASKED DISTRICT ATTORNEYS OFFICE.  
 WHEN I SUED DA, THE MOTION FOR DISCOVERY WAS DENIED  
 SAYING I ASKED FOR THE KITCHEN SINK,  
 NO DEFENSE, NO WITNESSES, NO SUBPENAS, NO EVIDENCE,  
 NO OPEN STATEMENT, NO PRESENTATION, AND HIS CLOSING WAS ON A THEORY  
 WAS BASE BALL  
 WHERE DID HE GET HIS LICENSE TO PRACTICE LAW  
 AND WHY DOES HE STILL HAVE IT WHAT IS HIS  
 OBLIGATION

1 PHYLLIS MORRIS  
Interim Public Defender  
2 CHRIS GARDNER  
Interim Assistant Public Defender, Main unit  
3 BY: David L. Sanders  
State Bar #: 78021  
4 Deputy Public Defender  
14344 Cajon Ave. Suite 201  
5 Victorville, CA 92392  
(760) 241-0413

6 *Attorney for Defendant, George Yablonsky*

7  
8 **SUPERIOR COURT OF THE STATE OF CALIFORNIA**  
9 **COUNTY OF SAN BERNARDINO, DESERT DIVISION**

10  
11 **PEOPLE OF THE STATE OF CALIFORNIA,**

12 *Plaintiff,*

13 vs.

14 **GEORGE YABLONSKY,**

15 *Defendant.*

Case No.: FVI 021929

NOTICE AND MOTION TO  
CONTINUE (PENAL CODE  
SECTION 1050);  
POINTS, AUTHORITIES AND  
ARGUMENT IN SUPPORT  
THEREOF.

17 PLEASE TAKE NOTICE that on January 14th, 2010, at 8:30 a.m., in  
18 Department V-3 of the above-entitled court, defendant will move the Court for an  
19 order continuing the jury trial in the above entitled matter to January 31st, 2011, or  
20 any other subsequent date permitted by the court.

21 Said motion is made pursuant to Penal Code section 1050 and is based on the  
22 attached Declaration and any evidence and argument that may be presented at the  
23 hearing.

24 DATED: January 12<sup>th</sup>, 2011

25 DAVID SANDERS  
Deputy Public Defender

26 *[Signature]*

27 JOHN YABLONSKY  
ATTORNEY  
28 CASE # FVI 900518

CONFLICT OF  
INTEREST OR  
FAIL TO PERFECT  
THIS CRUCIAL  
MOTION THAT  
WENT TOWARD  
ABILITY TO

~~INVESTIGATE~~  
INVESTIGATE

INSTEAD  
WE ANNOUNCED  
READINESS  
FOR TRIAL  
WHEN HE  
SHOULD HAVE  
INCAMERA  
MOTION 1050  
TO THE OFFICE  
DENIAL OF  
CONTINUANCE

1                                 **DECLARATION IN SUPPORT OF MOTION**

2 I, David L. Sanders, hereby declare:

- 3         1. That I am an attorney licensed to practice law in the State of California;  
4         2. That I represent the defendant in this action;  
5         3. That I believe that good cause exists to continue this matter based upon the  
6             following:

7             There are two potential witnesses who have been contacted by the  
8             prosecution to testify to Evidence Code Sec. 1108 evidence, that being  
9             alleged other instances of sexual criminal conduct. In prior  
10            conversations with the DA he informed me that he did not intend to call  
11            the two women. However, on Tuesday, January 11<sup>th</sup>, 2011, I was  
12            informed that the DA now does intend to call these women at the trial  
13            of this matter.

14            The defense needs contact information regarding these witnesses as he  
15            has not had an opportunity to interview them. One of the alleged  
16            instances is said to have occurred in El Paso, TX, in 1982. That woman  
17            now has a different last name. The other alleged incident is said to  
18            have occurred in 1996.

19            Neither of these women were located by the defense in their  
20            investigation

21 I declare under penalty of perjury that the foregoing is true and correct.

22 Executed on the 12th day of January, 2011, at Victorville, California.

23  
24  
25  
26 \_\_\_\_\_  
27 David L. Sanders  
28 Deputy Public Defender



# EXHIBIT COVER PAGE

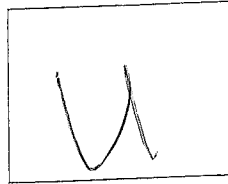

EXHIBIT

DESCRIPTION OF THIS EXHIBIT:

NUMBER OF PAGES TO THIS EXHIBIT: 2 PAGES

JURISDICTION: (CHECK ONLY ONE)

- MUNICIPAL COURT
- SUPERIOR COURT
- APPELLATE COURT
- STATE SUPREME COURT
- UNITED STATES DISTRICT COURT
- STATE CIRCUIT COURT
- UNITED STATES SUPREME COURT
- GRAND JURY

COPY

FILED  
SUPERIOR COURT OF CALIFORNIA  
COUNTY OF SAN BERNARDINO  
VICTORVILLE DISTRICT

AUG 06 2009

SUPERIOR COURT OF CALIFORNIA, COUNTY OF SAN BERNARDINO

*Marcia S. Ramirez*  
MARCIA S. RAMIREZ, DEPUTY

THE PEOPLE OF THE STATE OF CALIFORNIA,

Plaintiff

vs.

John Henry Yablonsky

Defendant

COURT CASE NO FVI900518

INFORMATION

Arraignment Date: 08/11/2009

Department: V2

DA CASE NO 2009-00-0013497

INFORMATION SUMMARY

Ct. No.	Charge	Charge Range Check Code	Defendant	Special Allegation	Alleg. Effect
1	PC187(a)		John Henry Yablonsky	PC190.2(a)(17)	LWOP/Death

*THIS IS ALL REAL  
WRONG WHAT ARE  
THEY DOING  
HOW COULD  
THIS BE*

The District Attorney of the County of San Bernardino, by this Information alleges that:

COUNT 1

On or about September 20, 1985, in the above named judicial district, the crime of MURDER, in violation of PENAL CODE SECTION 187(a), a felony, was committed by John Henry Yablonsky, who did unlawfully, and with malice aforethought murder Rita Mabel Cobb, a human being.

*ATTORNEY SAID THIS  
WAS NOT  
DEATH POSSIBILITIES  
STUPID  
INCOMPETENT  
THIS COMPLAINT  
HAS DEATH  
CAPABILITIES*

"NOTICE: The above offense is a serious felony within the meaning of Penal Code section 1192.7(c) and a violent felony within the meaning of Penal Code section 667.5(c)."

"NOTICE: Conviction of this offense will require you to provide specimens and samples pursuant to Penal Code section 296. Willful refusal to provide the specimens and samples is a crime."

It is further alleged as to count 1 that the murder of Rita Mabel Cobb was committed by defendant John Henry Yablonsky while the said defendant was engaged in the commission of and/or the attempted commission of the crime of rape in violation of Penal Code Section 261.

(11)

"NOTICE: Conviction of this offense will require you to register pursuant to Penal Code section 290. Willful failure to register is a crime."

\*\*\*\*\*

\* \* \* \* \*

NOTICE TO DEFENDANT AND DEFENDANT'S ATTORNEY  
Pursuant to Penal Code Sections 1054.5.(b), the People are hereby informally requesting that defense counsel provide discovery to the People as required by Penal Code Section 1054.3.

NOTICE TO ATTORNEY

The materials accompanying this notice may include information about witnesses. If so, these materials are disclosed to you pursuant to Penal Code section 1054.2 which provides: "No attorney may disclose or permit to be disclosed to a defendant the address or telephone number of a victim or witness whose name is disclosed to the attorney pursuant to subdivision (a) of Section 1054.1 unless specifically permitted to do so by the court after a hearing and a showing of good cause."

THIS INFORMATION CONSISTS OF 1 COUNT(S).

MICHAEL A. RAMOS  
DISTRICT ATTORNEY  
County of San Bernardino  
State of California

By: John Thomas  
John Thomas  
Deputy District Attorney

Filed in Superior Court,  
County of San Bernardino

Dated: \_\_\_\_\_

2

# EXHIBIT COVER PAGE

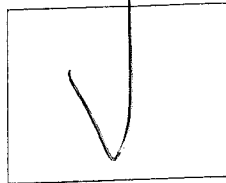

EXHIBIT

DESCRIPTION OF THIS EXHIBIT:

NUMBER OF PAGES TO THIS EXHIBIT: 1 PAGES

JURISDICTION: (CHECK ONLY ONE)

MUNICIPAL COURT

SUPERIOR COURT

APPELLATE COURT

STATE SUPREME COURT

UNITED STATES DISTRICT COURT

STATE CIRCUIT COURT

UNITED STATES SUPREME COURT

GRAND JURY

129  
202

# Yablonsky guilty in cold case killing

BY TOMOYA SHIMURA  
STAFF WRITER

VICTORVILLE • John Yablonsky charged with the 1985 murder of a Liverne Valley woman, was convicted late Thursday afternoon in Victorville Superior Court.

After three days of deliberations, a jury came back with the verdict finding Yablonsky guilty of the murder of Rita M. Cobb and special circumstances of rape. The 47-year-old defendant is expected to be sentenced to life in prison without parole on April 8.



John Yablonsky

The jurors almost during Wednesday night — eight for guilty and four for not guilty, but Judge John Tompkins told them to continue deliberating one more day.

Hearing the guilty verdict, Daryl Kraemer, the victim's son who was sitting in the audience with his wife, quietly wiped away tears.

"It's just a joy," Kraemer said. "The jurors made the right decision."

SEE GUILTY PAGE 7

*AFTER STOCKWELL TESTIFIED THE DNA COULDA BEEN AT SCENE HOMES AND EVEN PLAYS BEFORE CRIME REASONABLE DOUBT WAS INSERTED AND THERE IS NO OTHER EVIDENCE*

## FROM THE FRONT

Daily Press Page edited by Mike Lamb

Friday, February 4, 2011 PAGE A7

# GUILTY: Some jurors felt they needed more evidence

FROM PAGE 1

Kraemer thanked the jurors in the court hallway and a male juror told him, "I hope it brings peace to your family."

Kraemer and his wife, Marta, discovered Cobb naked on her bed in her house more than 25 years ago. The victim had been strangled to death with a wire coat hanger.

Yablonsky wasn't arrested until March 2009

when San Bernardino County Sheriff's officials matched his DNA with evidence discovered at the murder scene. The investigation took so long because DNA science was still in its infancy in 1985.

Some jurors told attorneys in the hallway it took them a while to reach the verdict because they felt they needed more evidence.

"I'm disappointed

because I thought we had good evidence," said Deputy Public Defender Dave Sanders. Yablonsky's attorney, I thought there was serious reasonable doubt concerning my client's guilt.

I felt it wasn't entirely clear what happened 25 years ago.

Cold cases can be difficult to try because witnesses from decades earlier can't be found or

have died and evidence sometimes inadvertently gets lost or destroyed, Deputy District Attorney John Thomas said.

"I'm just happy they came back with a guilty verdict," Thomas said. I hope it gives some closure to Daryl and Marta.

During the interview with detectives, Yablonsky recognized Cobb in a photo. He and

his family used to rent Cobb's back house until they moved out about a year before her death.

But Yablonsky repeatedly denied ever having a personal or sexual relationship with the victim during the interview with detectives.

Because Yablonsky's DNA was found on Cobb, some jurors said they felt like Yablonsky was lying. "Twenty-five years of

guessing and thinking about what I could have done to change things at that time. It made me feel miserable," Kraemer said.

Did the verdict help ease the burden?

"Now I can start working on it," Kraemer said.

Tomooya Shimura may be reached at tshimura@VVDailyPress.com or (760) 955-5368.

*A DOCTORED RECORDING WILL SURE HELP A CONVICTION*

3 EACH